

Metric

B&T



Metric

Seating Systems

Indoor



Metric

Seating Systems

Indoor

Metric

Metric stands out with the dynamic silhouette of its vertical carriers at different heights and the vibrant rhythm it adds to the space.

Metric

Seating Systems

Indoor





The high and low backrest surfaces are treated as both a carrier and an element that creates the rhythm of the extraordinary aesthetics of the design.

Designer

Alp Nuhoglu - 2025

Metric

Seating Systems

Indoor





Metric

Seating Systems

Indoor



Fixed back cushions are part of the design and maximize comfort. Its structure, open to modulation options, allows for customization and space-specific placement.



In addition to different color and fabric combinations, the optional neolith, lacquered, natural veneer, or marble coffee table option increases its functionality.



Metric

Seating Systems

Indoor

Finish Options

A rich range of material choices is provided for Metric series to create the best match within interior style.

Metal Finishes

Electrostatic Powder Coating

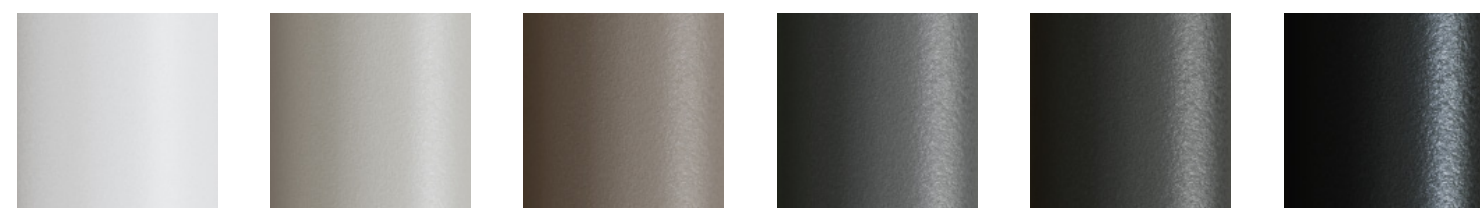

White RAL 9016	Silk Grey RAL 7044	Taupe G 876	Grey G 458	Anthracite RAL 7016	Black RAL 9005
-------------------	-----------------------	----------------	---------------	------------------------	-------------------



Cement Grey RAL 7033	Green Grey RAL 7009	Precious Sand	Metallic Earth	Beige Red RAL 3012	Terracotta RAL 8004
-------------------------	------------------------	---------------	----------------	-----------------------	------------------------

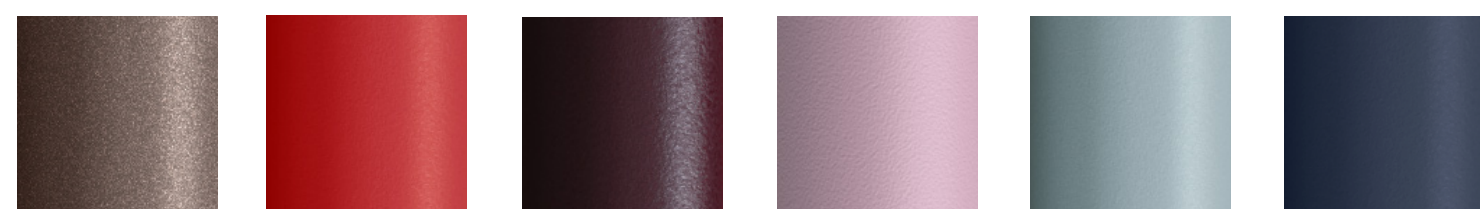

Bronze	Tomato Red RAL 3013	Black Red RAL 3007	Pastel Violet RAL 4009	Nordic Lichen	Steel Blue RAL 5011
--------	------------------------	-----------------------	---------------------------	---------------	------------------------



Gold



SIDE TABLE LEG

METAL BASE FRAME

Metal base frame and side table leg will be the same selected color.

Table Top Materials

Natural Veneer (18 mm)



White
RAL 110-1
(Ash)



Silk Grey
RAL 7044
(Ash)



Taupe
G 876
(Ash)



Grey
G 458
(Ash)



Anthracite
RAL 7016
(Ash)



Black
RAL 9005
(Ash)



Cement Grey
RAL 7033
(Ash)



Green Grey
RAL 7009
(Ash)



Precious
Sand
(Ash)



Light Mocha
(Ash)

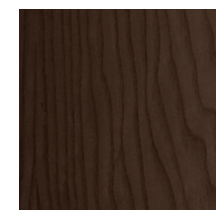

Dark Mocha
(Ash)



Natural
(Ash)



Metalic
Earth
(Ash)



Beige Red
RAL 3012
(Ash)



Terracotta
RAL 8004
(Ash)



Tomato Red
RAL 3013
(Ash)



Black Red
RAL 3007
(Ash)



Pastel Violet
RAL 4009
(Ash)



Nordic
Lichen
(Ash)



Steel Blue
RAL 5001
(Ash)

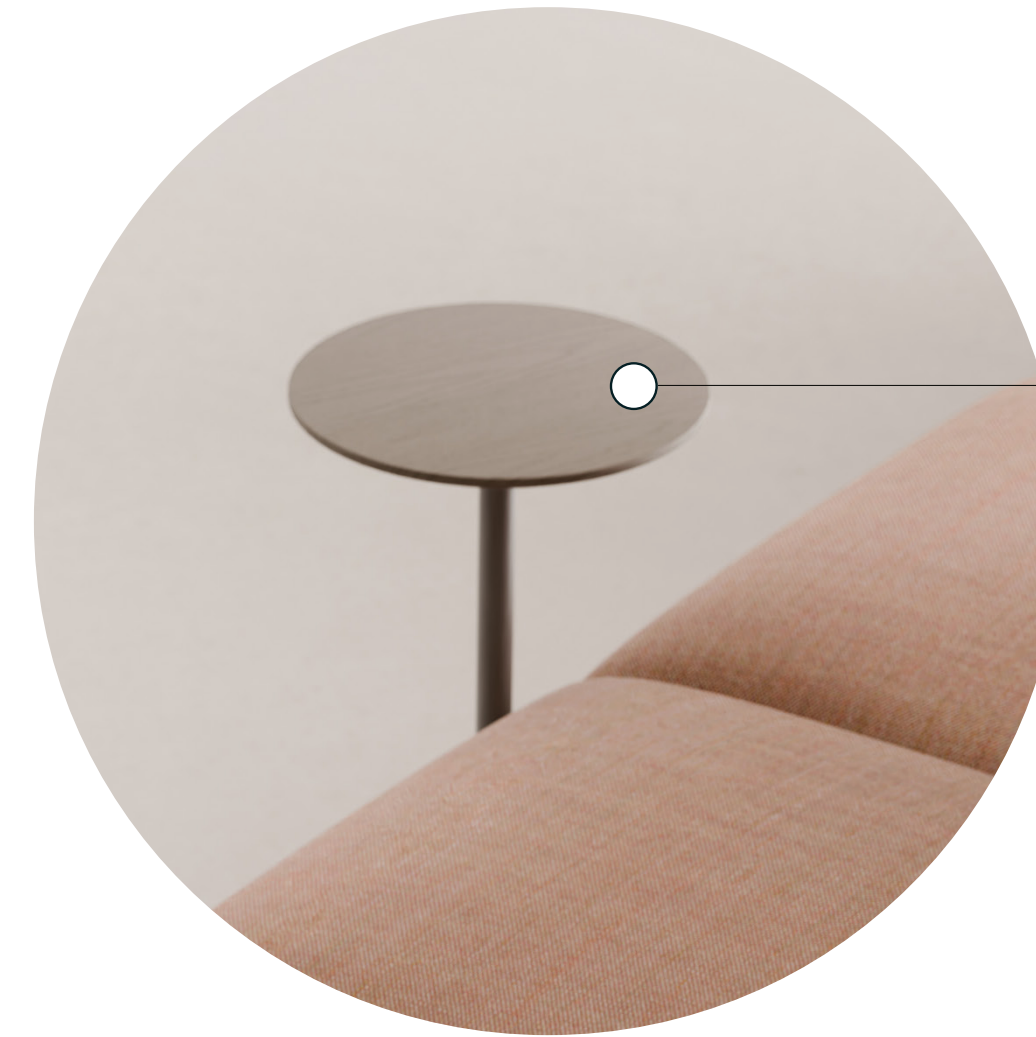

TABLE TOP

Table Top Materials

Neolith® (6 mm)



Calacatta Gold - Silk



Pietra Di Luna - Silk



Pietra Di Osso - Silk

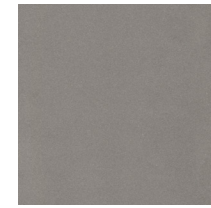

Cement - Satin



Nero Zimbabwe - Riverwashed

Marble (20 mm)

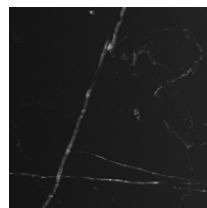

Toros Black

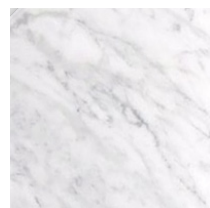

Carrara White



Cherry Red

Upholstery

Fabric, Leather, Artificial Leather.
COM and COL options are also available

textile fabric yardage (mt)	Short Backrest	1.50
	Tall Backrest	1.50
	2 Seater	1.70
	3 Seater	2.40
	4 Seater	3.00
	Pillow	0.65
real leather square meter (m ²)	Short Backrest	2.25
	Tall Backrest	2.25
	2 Seater	2.55
	3 Seater	3.60
	4 Seater	4.50
	Pillow	0.98

More options are downloadable in the catalogues

MATERIAL CATALOGUE 

FABRIC & LEATHER CATALOGUE 



The seating modules (2, 3, and 4-seater) is made as a single piece; therefore, one fabric must be selected per module. It cannot be upholstered in multiple fabrics.

The backrest and armrest **within the same module must be chosen from the same fabric category** as the selected seating upholstery.

(For example, if fabric **category A** is selected for the seat, the backrest and armrest must also be selected from fabric **category A**.)

For pricing information on alternative combinations, please contact our sales department.

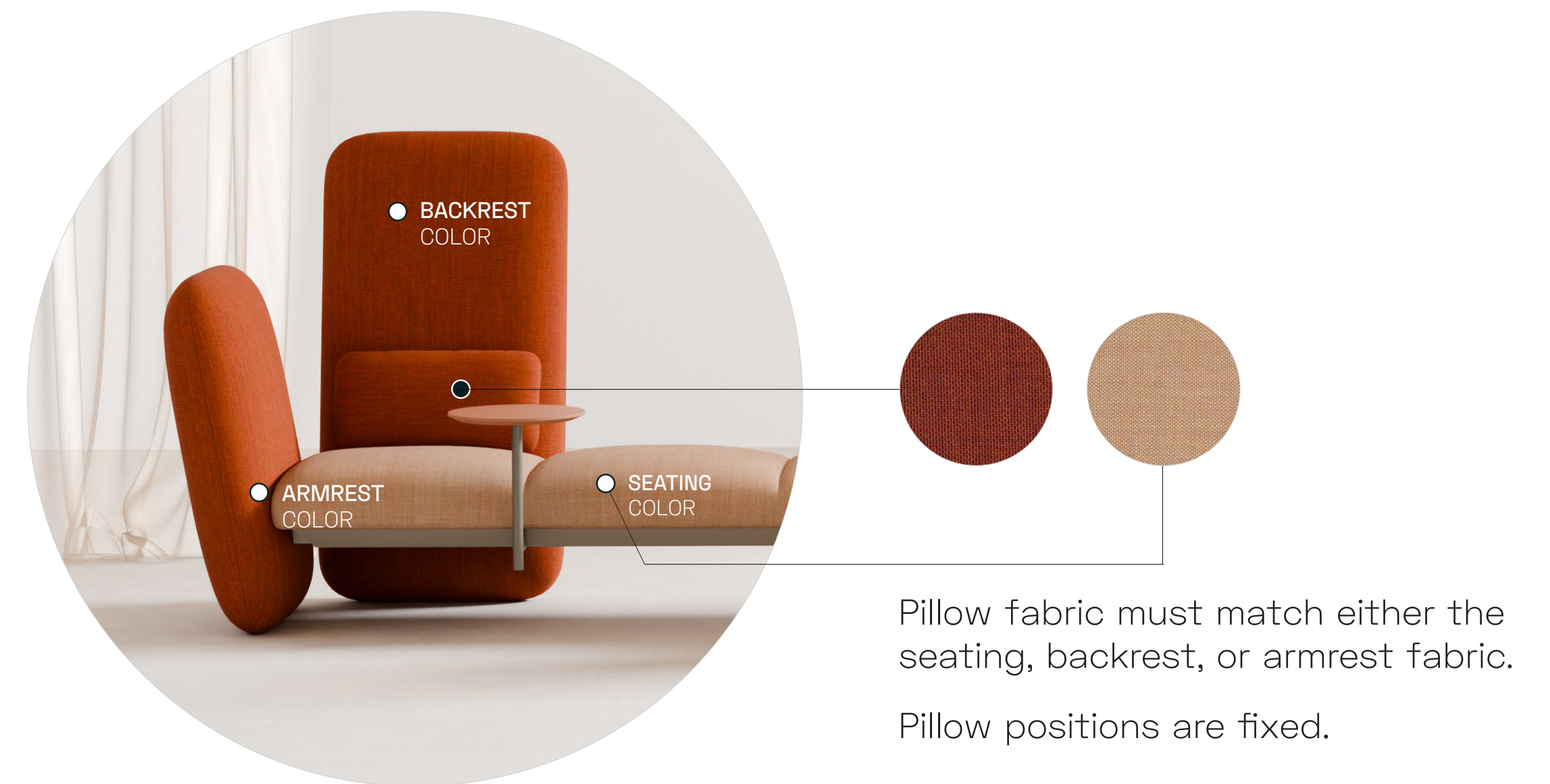

Pillow fabric must match either the seating, backrest, or armrest fabric.

Pillow positions are fixed.

METRIC INSPIRATION BOARD

As a highly configurable system, Metric invites a considered interplay of proportions, fabrics, finishes and optional tabletops, enabling bespoke compositions for any environment.

For this inspiration guide, our stylist Aslı Gürşen presents refined colour and material pairings: concise, evocative directions that simplify specification and help realise Metric's design intent.



CAMIRA | REPLAY
SKIP REP13 CAMIRA | REPLAY
AGILE REPO2 CAMIRA | REPLAY
FLEX REPO1

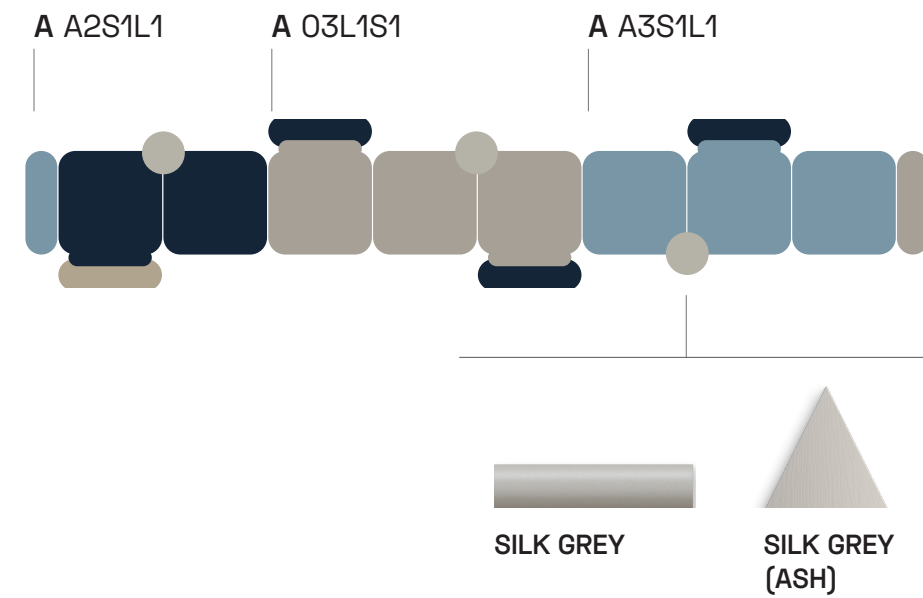

SILK GREY SILK GREY
(ASH)



CAMIRA | MLF
UPMINSTER MLF20 CAMIRA | MLF
BANK MLF23 CAMIRA | MLF
BARKING MLF45

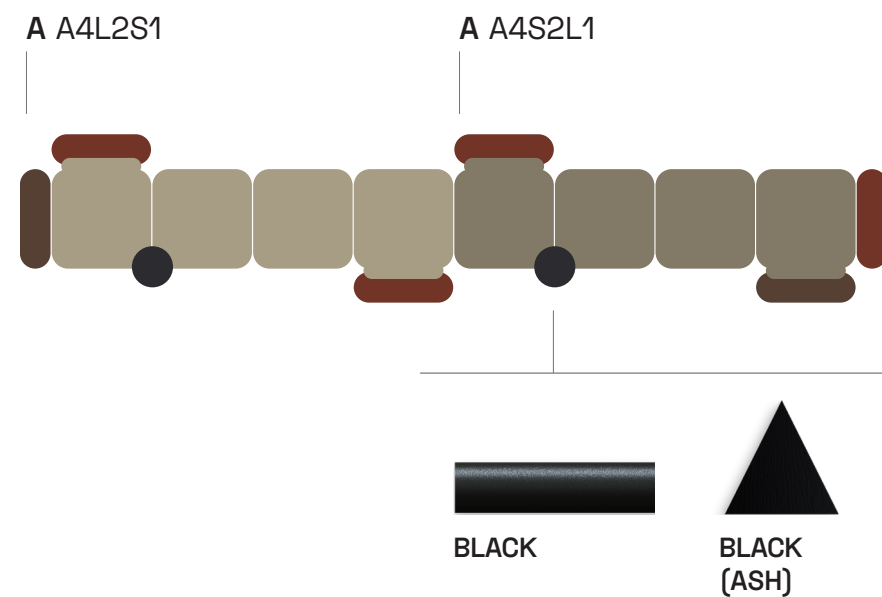

BLACK BLACK
(ASH)



CAMIRA | ASPECT
CAPPADOCIA ACT04 CAMIRA | ASPECT
PETRA ACT07 CAMIRA | ASPECT
MATTERHORN ACT19

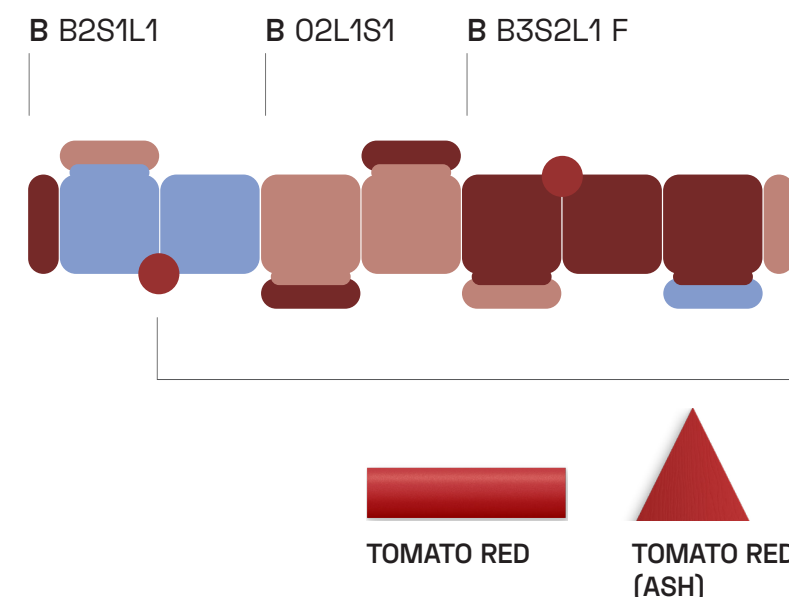

TOMATO RED TOMATO RED
(ASH)



CAMIRA | ASPECT
MARAKECH ACT03 CAMIRA | ASPECT
PETRA ACT07 CAMIRA | OCEANIC
CORAL OOC05 CAMIRA | OCEANIC
ABYSS OOC10

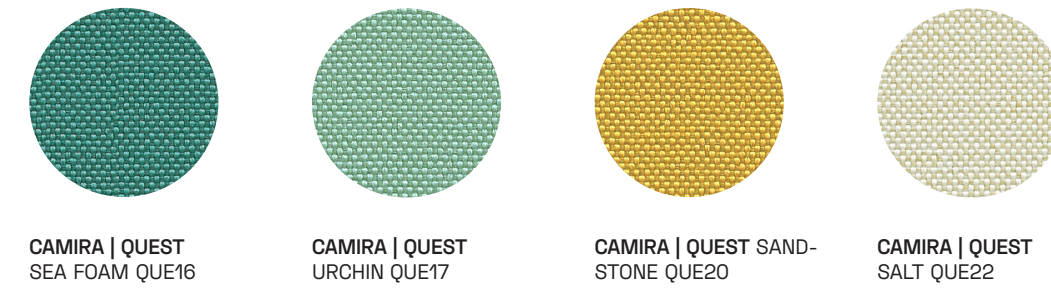

CAMIRA | QUEST
SEA FOAM QUE16 CAMIRA | QUEST
URCHIN QUE17 CAMIRA | QUEST
SANDSTONE QUE20 CAMIRA | QUEST
SALT QUE22

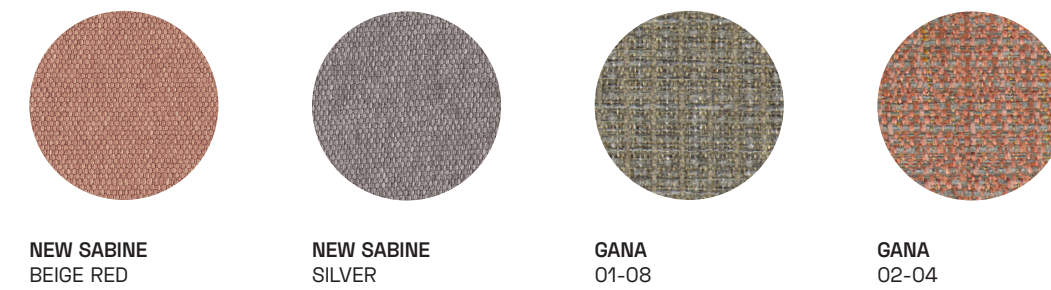

NEW SABINE
BEIGE RED NEW SABINE
SILVER GANA
01-08 GANA
02-04

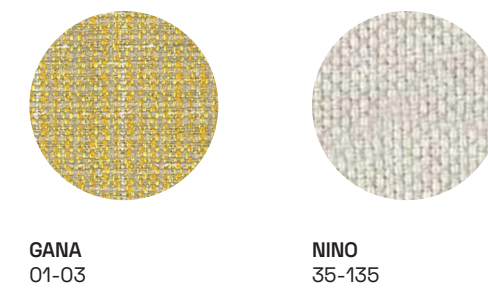

GANA
01-03 NINO
35-135

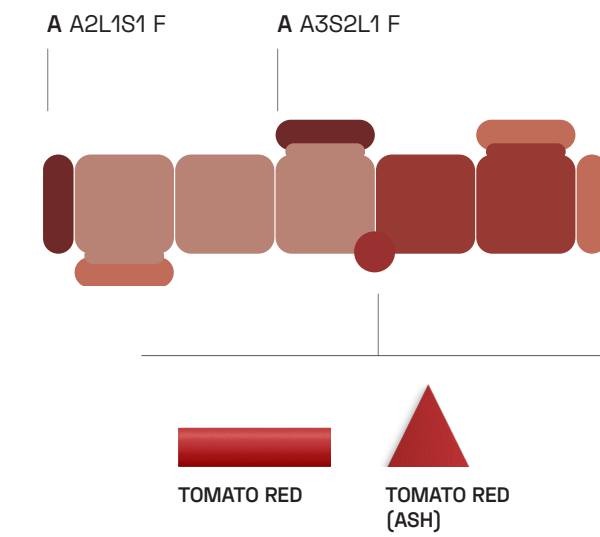

TOMATO RED TOMATO RED
(ASH)

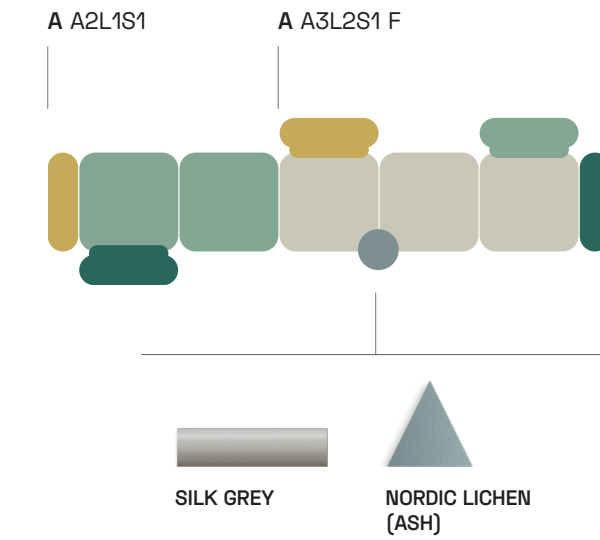

SILK GREY NORDIC LICHEN
(ASH)

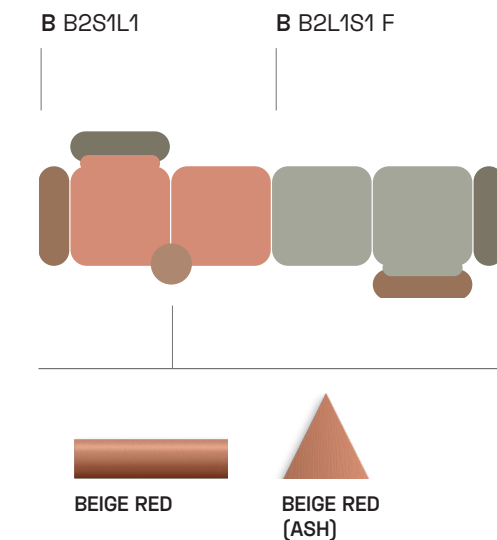

BEIGE RED BEIGE RED
(ASH)

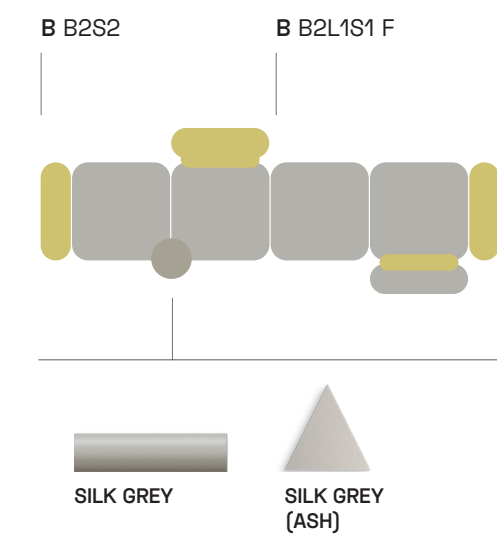

SILK GREY SILK GREY
(ASH)

Colors may slightly vary due to photographic lighting sources or your monitor settings.



Metric

Seating Systems

Indoor



Metric

Seating Systems

Indoor

Dimensions (cm)

Standalone

Standalone benches can be ordered individually, cannot be configured.

**Four Seater Bench
K4L2S2**

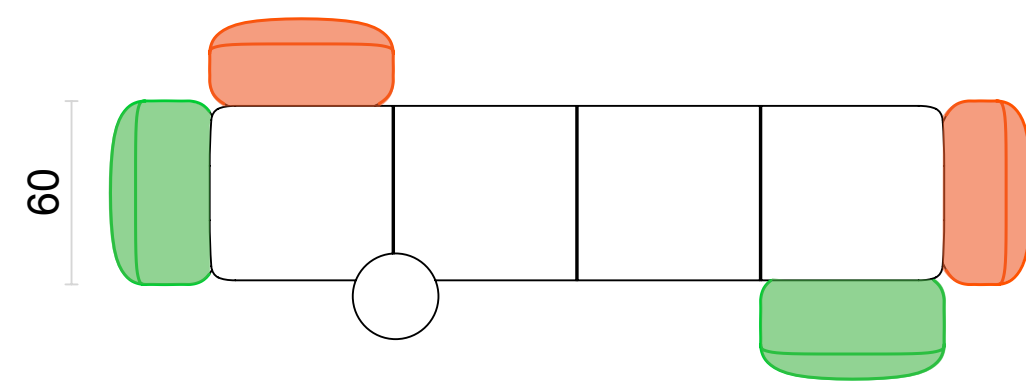
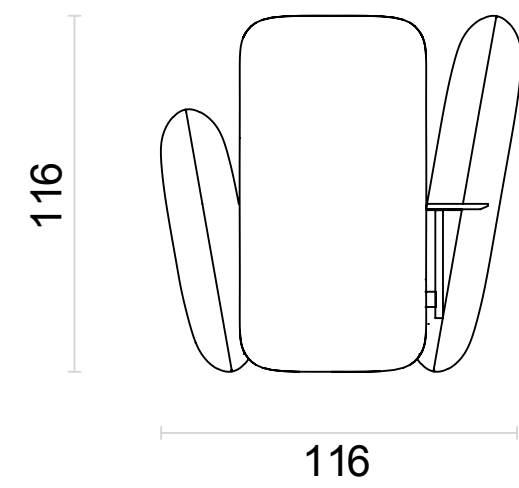
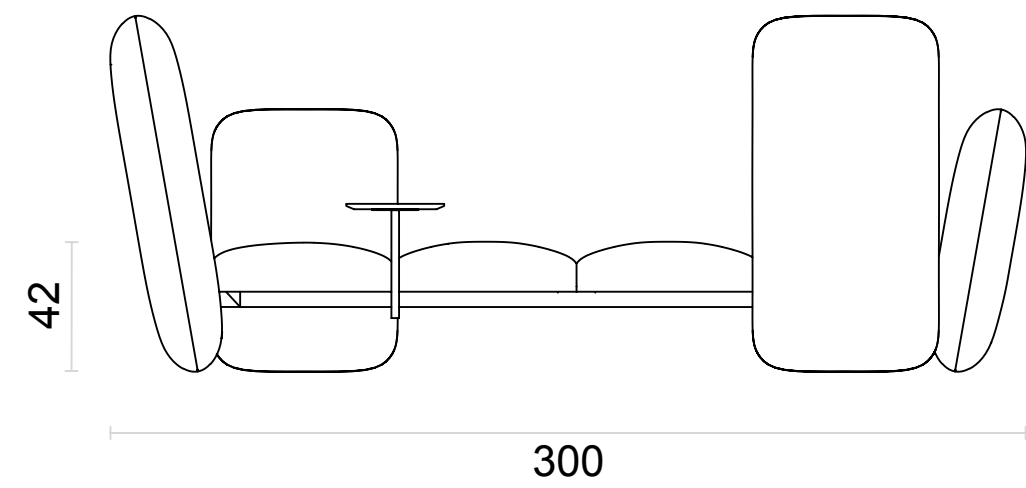

LOW
BACKREST

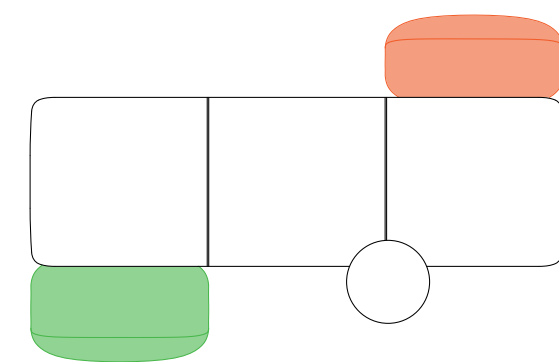

HIGH
BACKREST

**Four Seater Bench
K4S2L2**

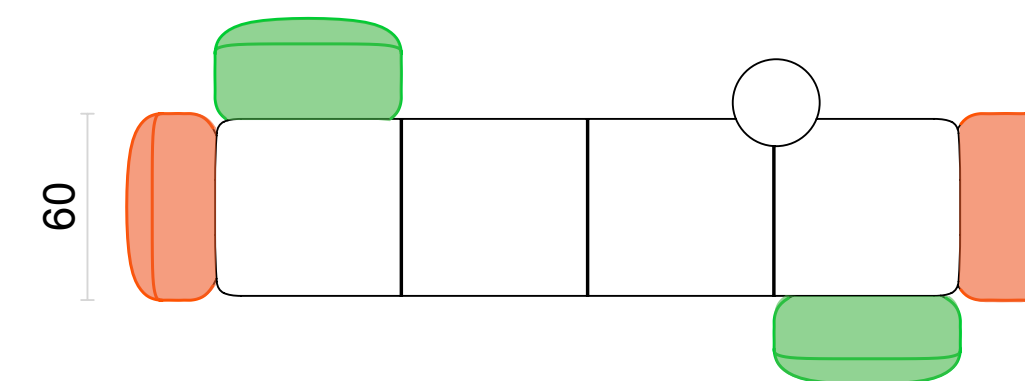
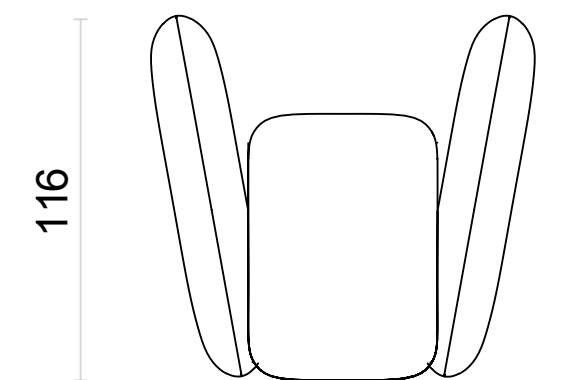
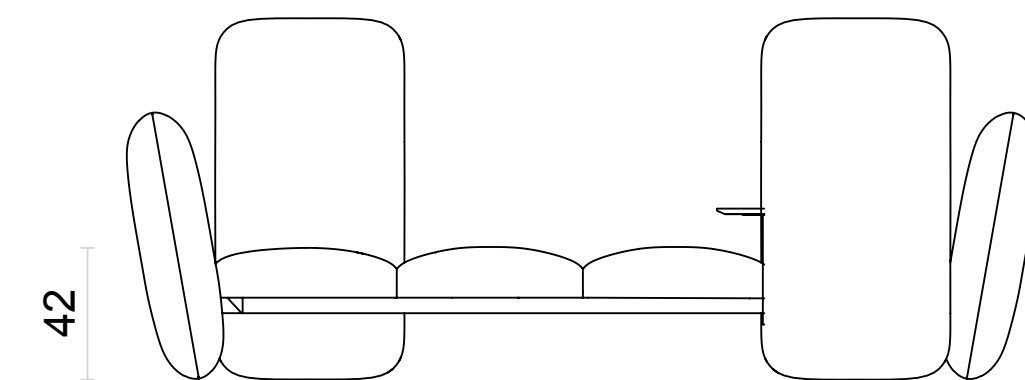

Dimensions (cm)

Standalone

Standalone benches can be ordered individually, cannot be configured.

Four Seater Bench
K4L2S2 F

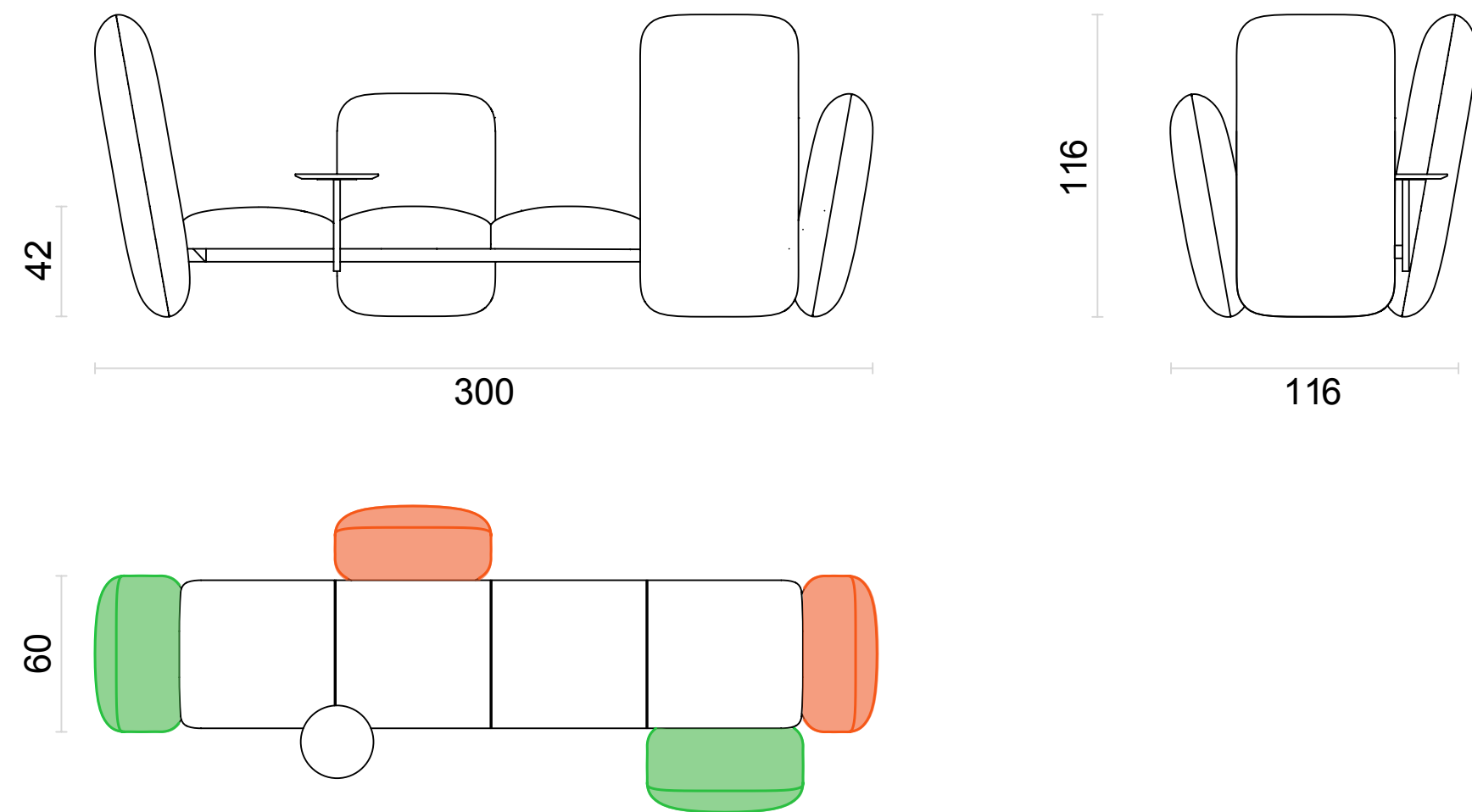

Four Seater Bench
K4S2L2 F

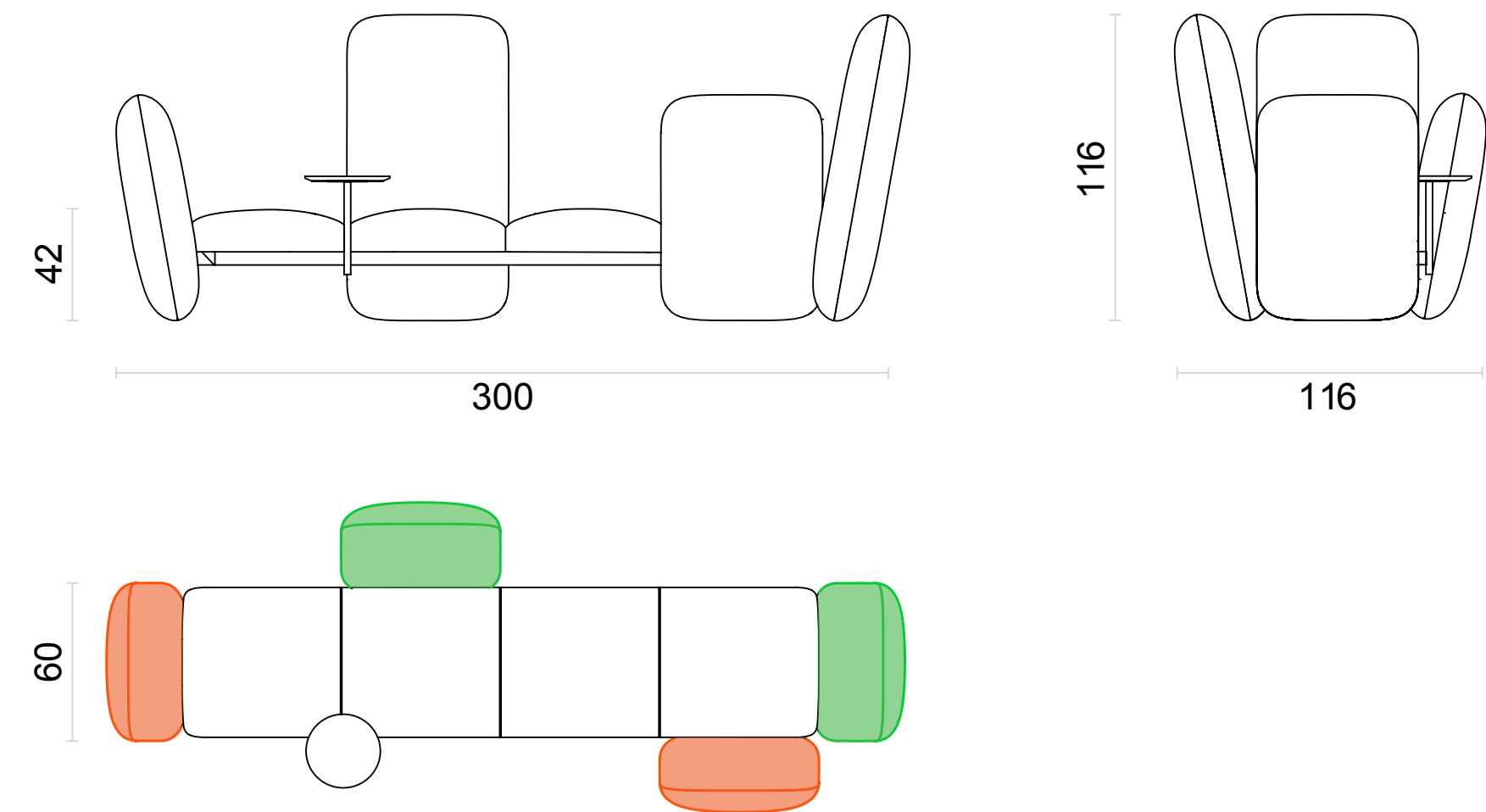

Dimensions (cm)

Standalone

Standalone benches can be ordered individually, cannot be configured.

**Three Seater Bench
K3L1S2**

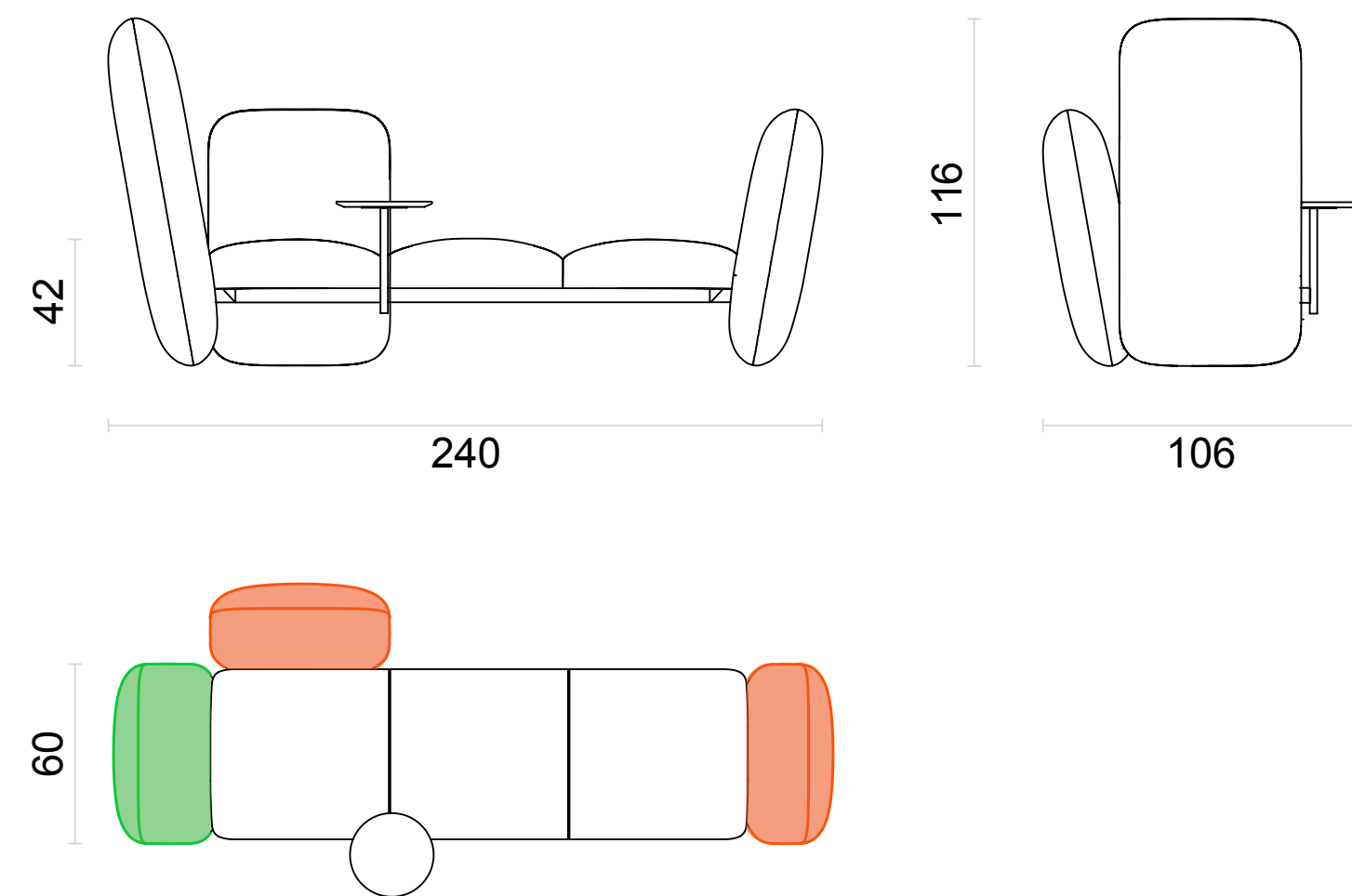

**Three Seater Bench
K3L1S2 F**

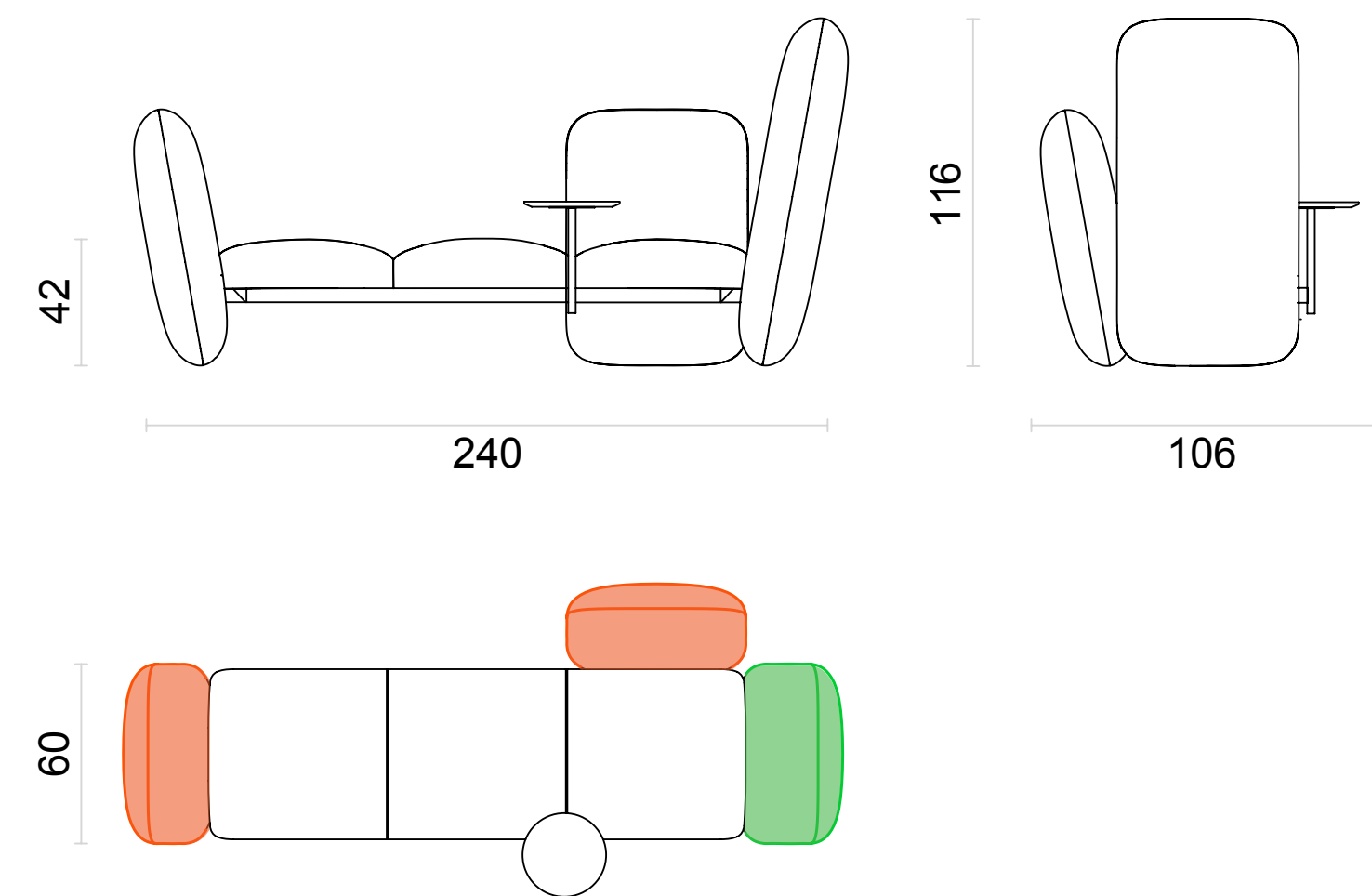

Dimensions (cm)

Standalone

Standalone benches can be ordered individually, cannot be configured.

**Three Seater Bench
K3S2L1**

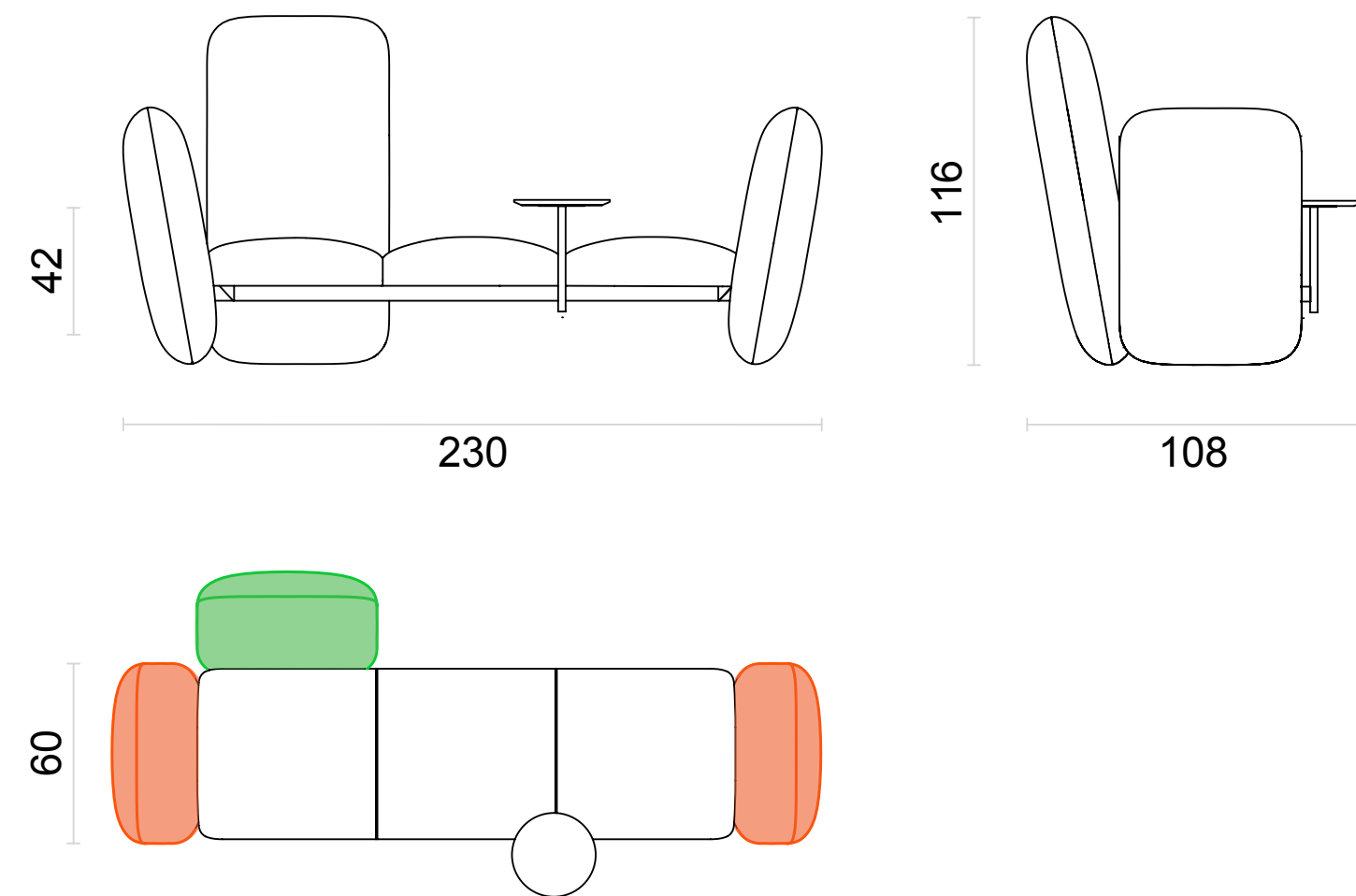

**Three Seater Bench
K3S2L1 F**

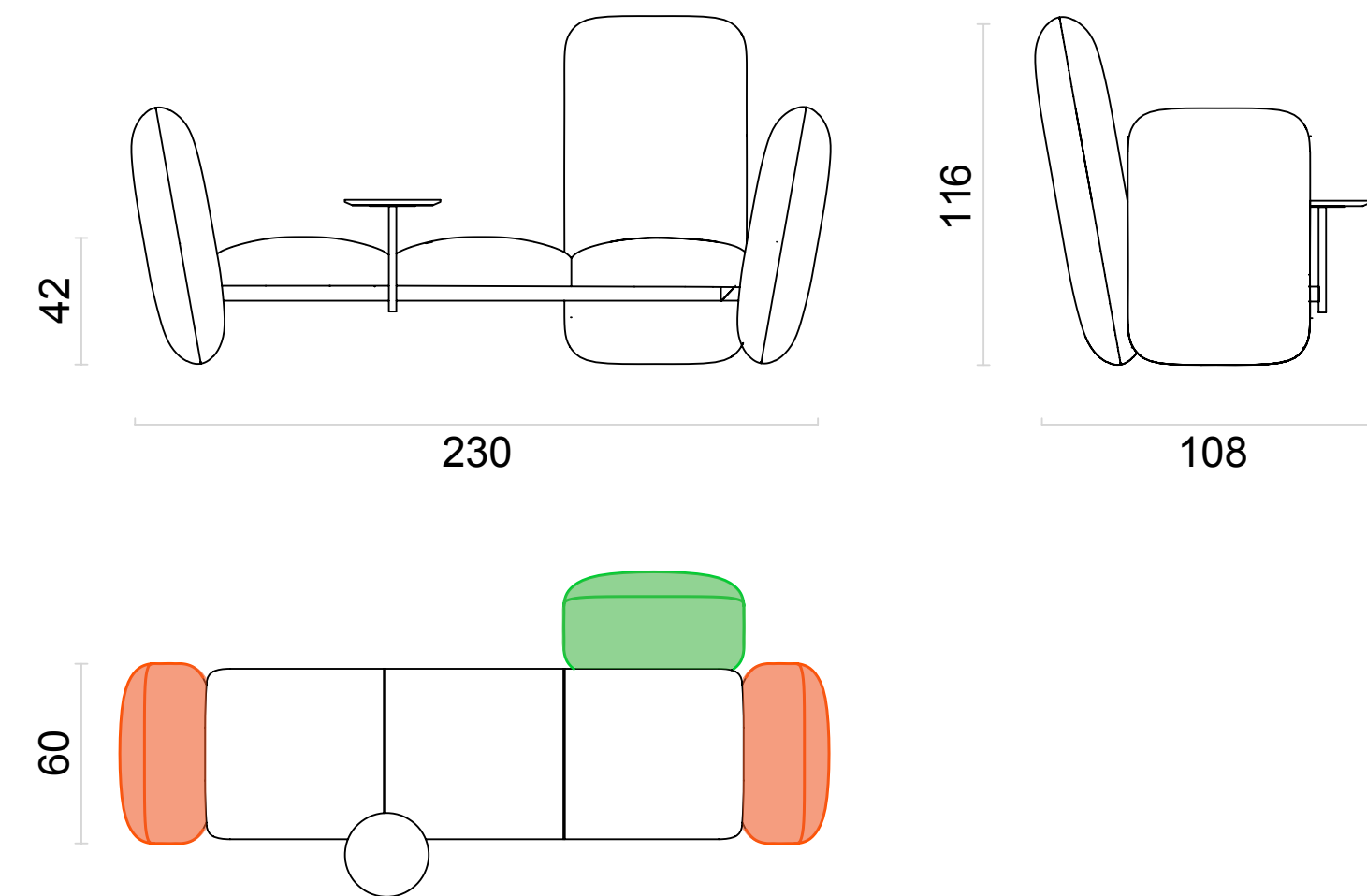

Sample Grouping A

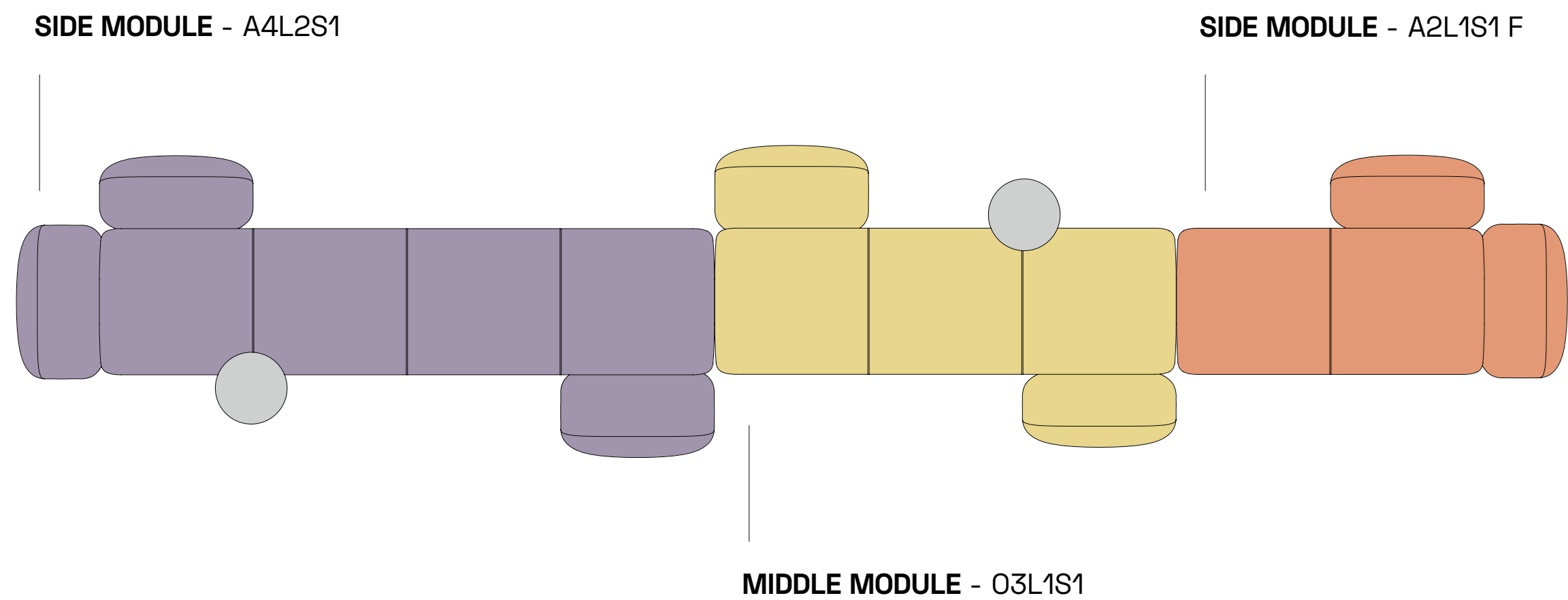
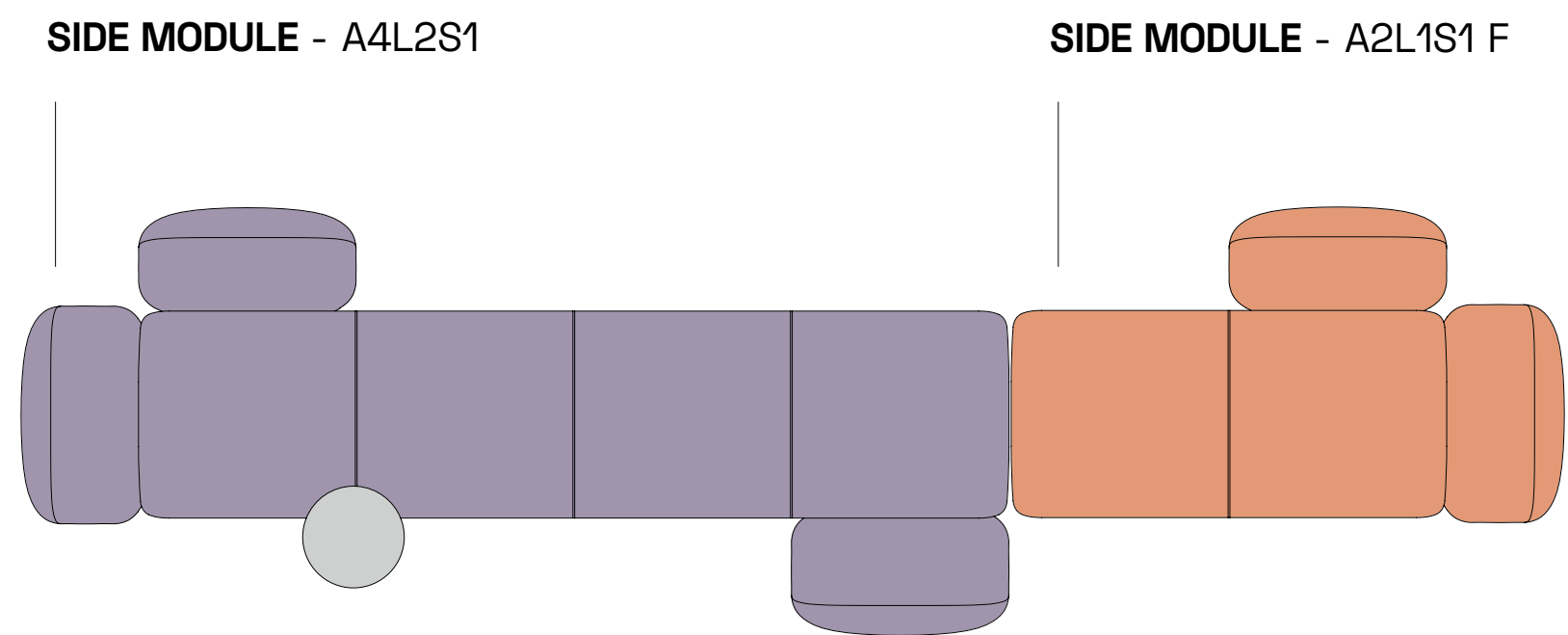

Dimensions (cm)

Side Modules - Group A

Side modules cannot be sold as a single unit.
Modules can only be matched within the same
group to create custom configurations.

Side Module
A4L2S1

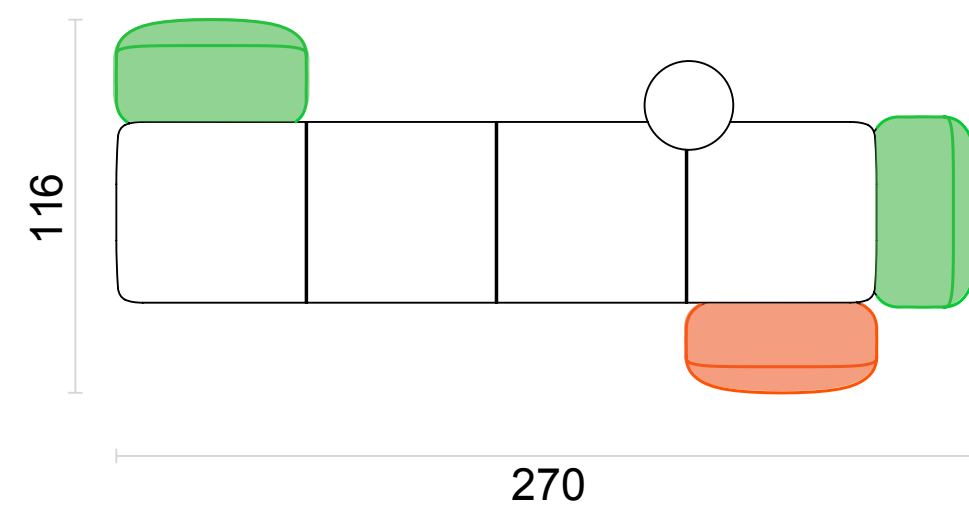

Side Module
A4S2L1

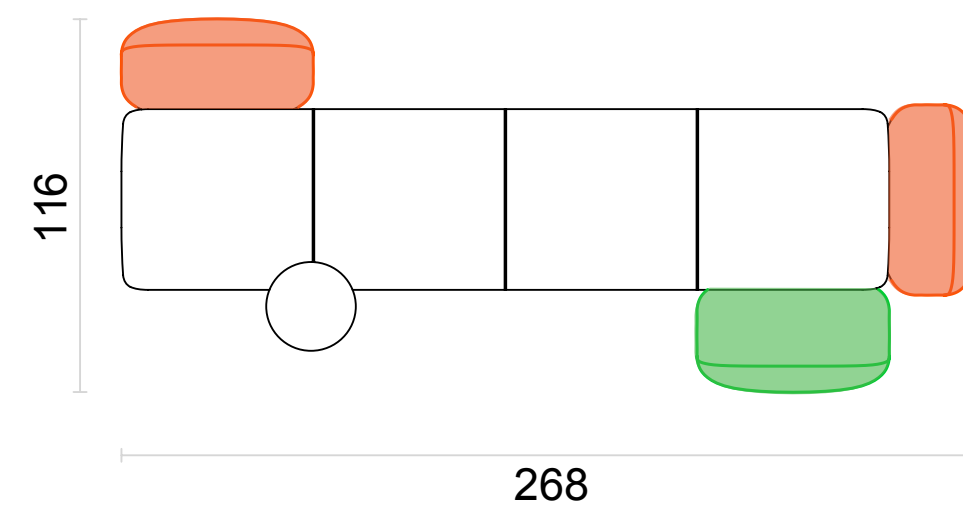

Side Module
A3S2L1

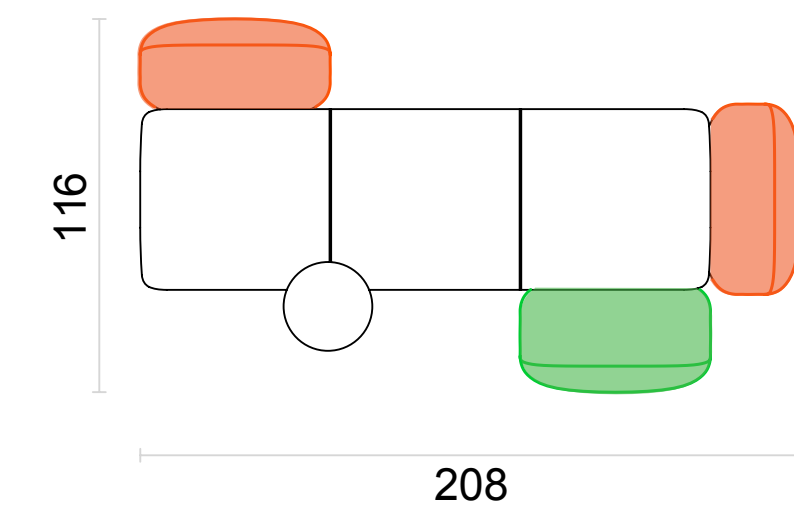

Dimensions (cm)

Side Modules - Group A

Side modules cannot be sold as a single unit. Modules can only be matched within the same group to create custom configurations.

Side Module
A3L2S1

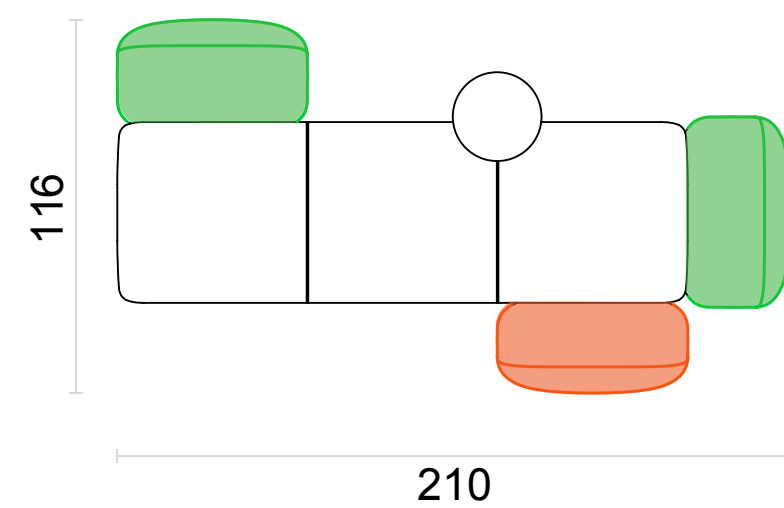

Side Module
A3S1L1

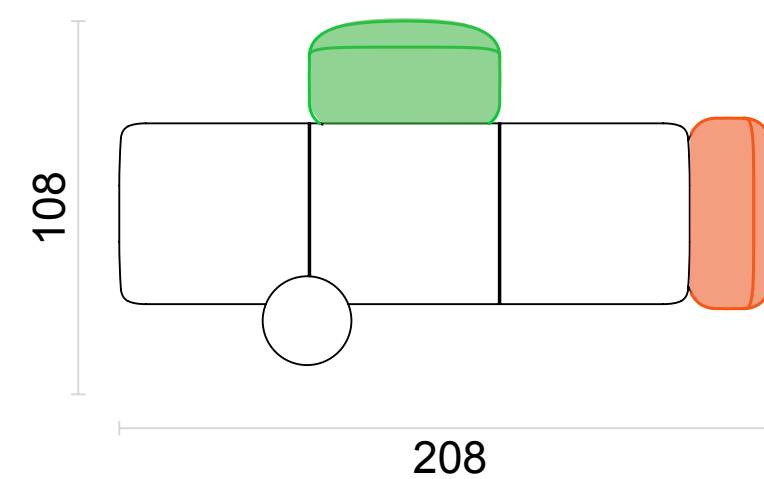

Side Module
A3L1S1

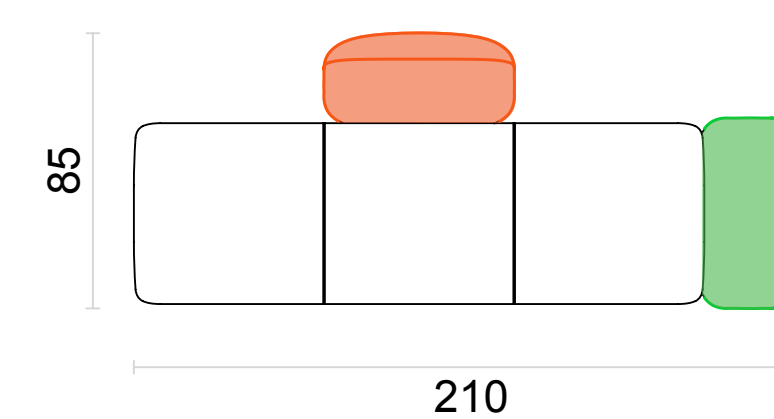

Dimensions (cm)

Side Modules - Group A

Side modules cannot be sold as a single unit. Modules can only be matched within the same group to create custom configurations.

Side Module
A3L2S1 F

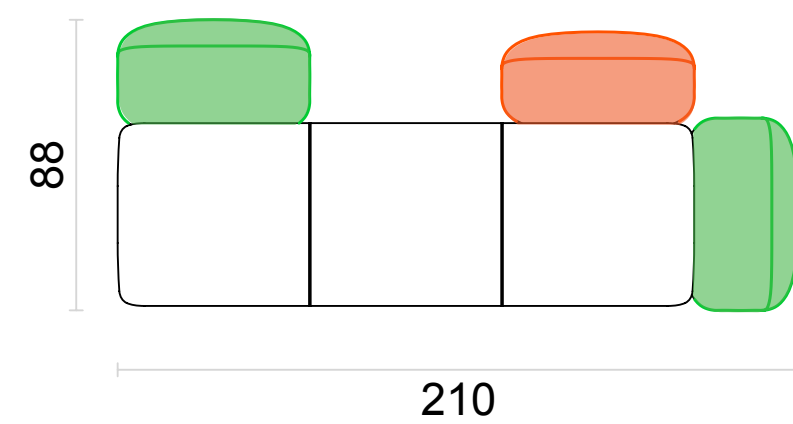

Side Module
A3S2L1 F

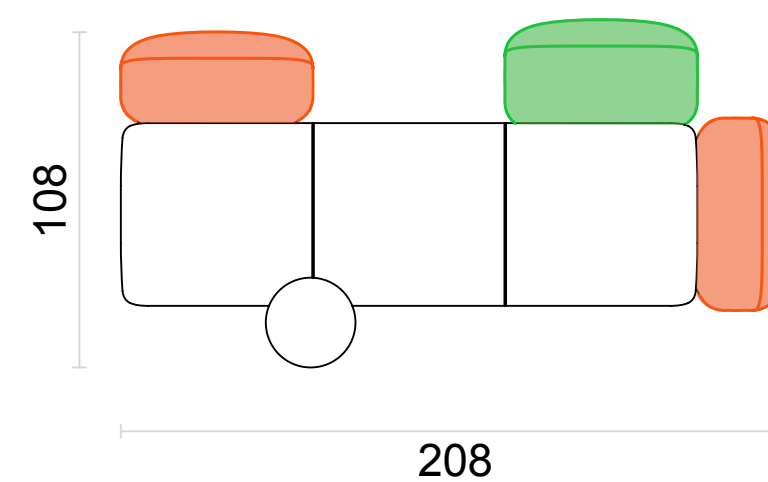

Side Module
A2L1S1

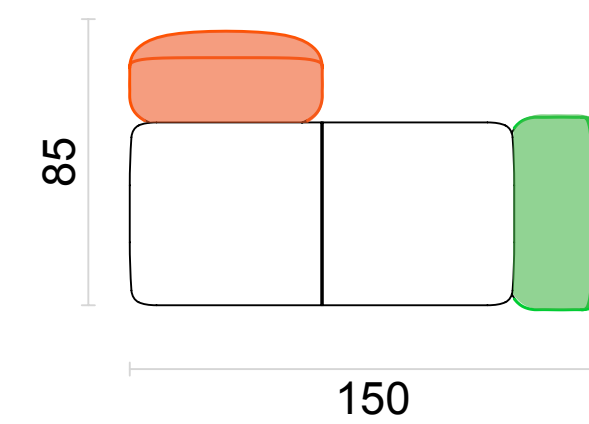

Dimensions (cm)

Side Modules - Group A

Side modules cannot be sold as a single unit. Modules can only be matched within the same group to create custom configurations.

Side Module
A2S1L1

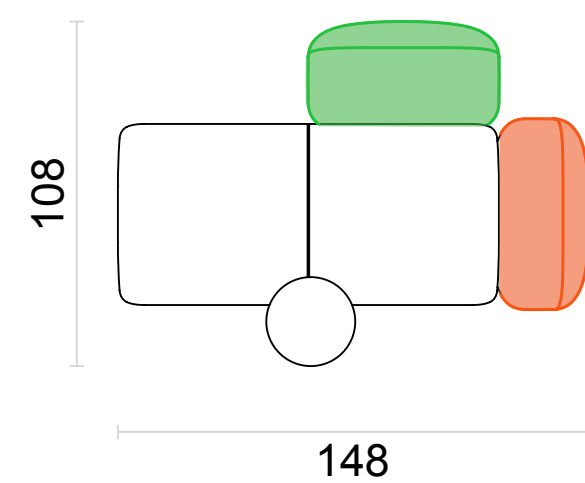

Side Module
A2S2

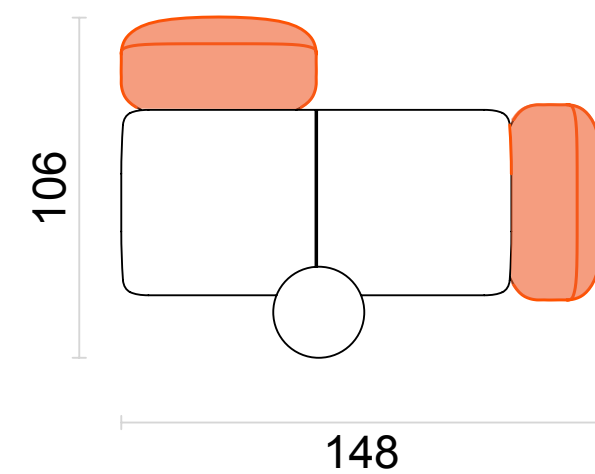

Side Module
A2L1S1 F

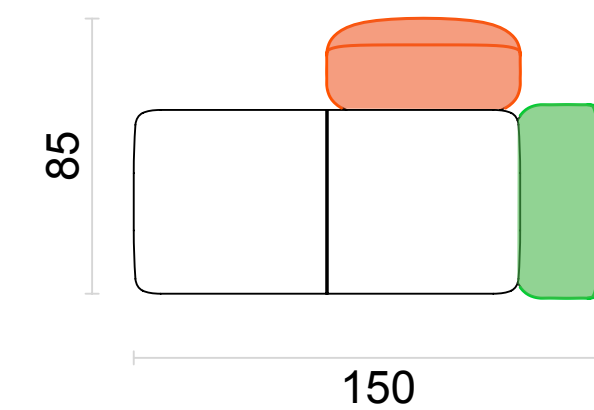

Dimensions (cm)

Middle Modules - Group A

Middle Module
A02S1L1

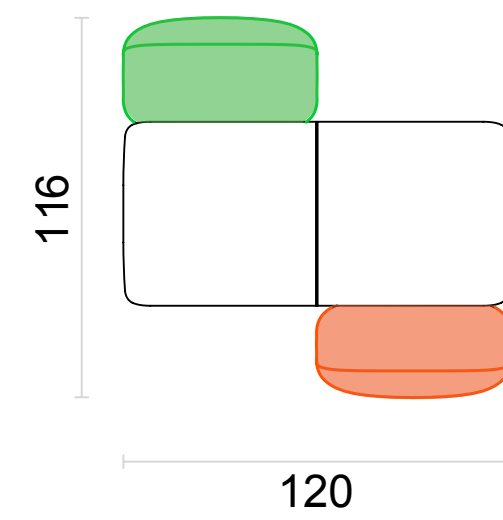

Middle Module
A03L1S1

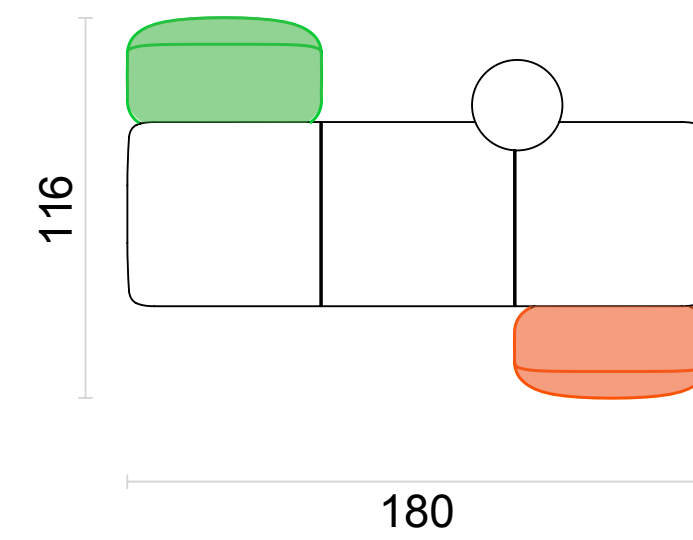

Sample Grouping B

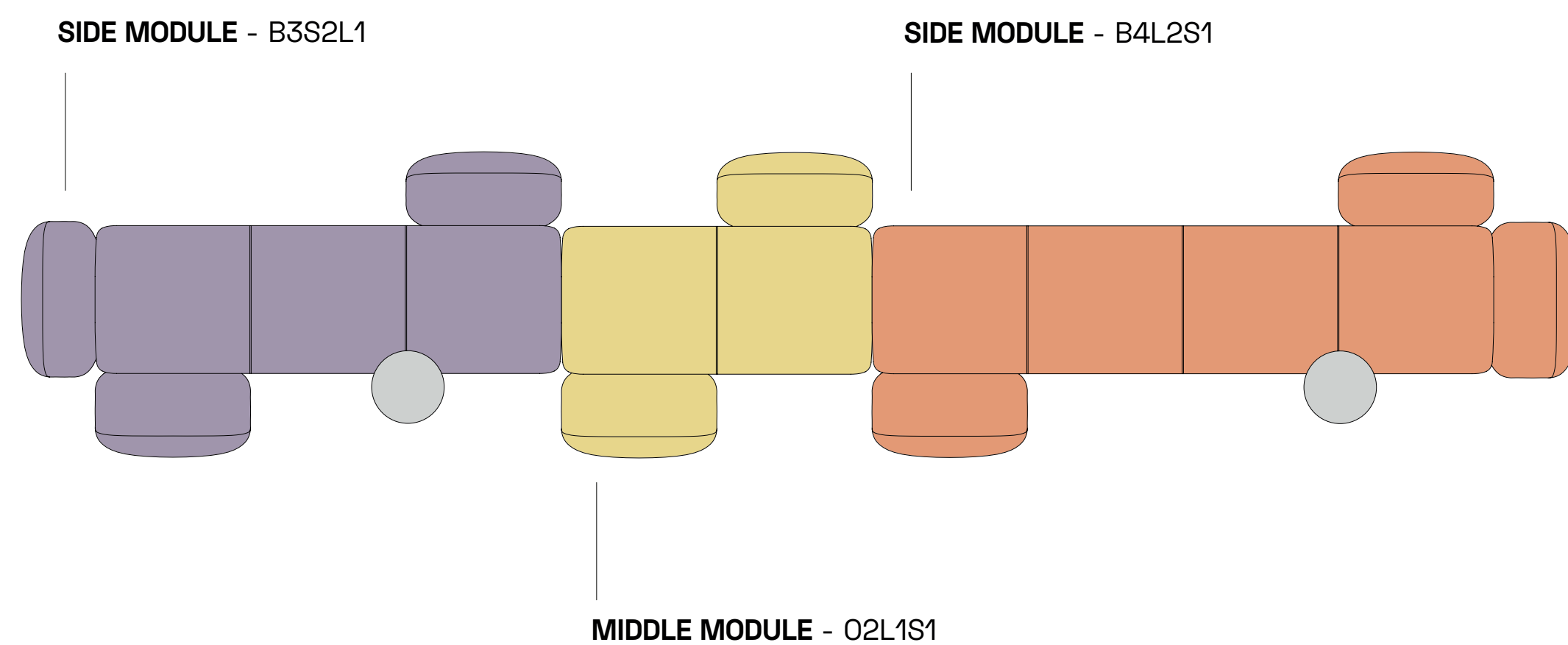
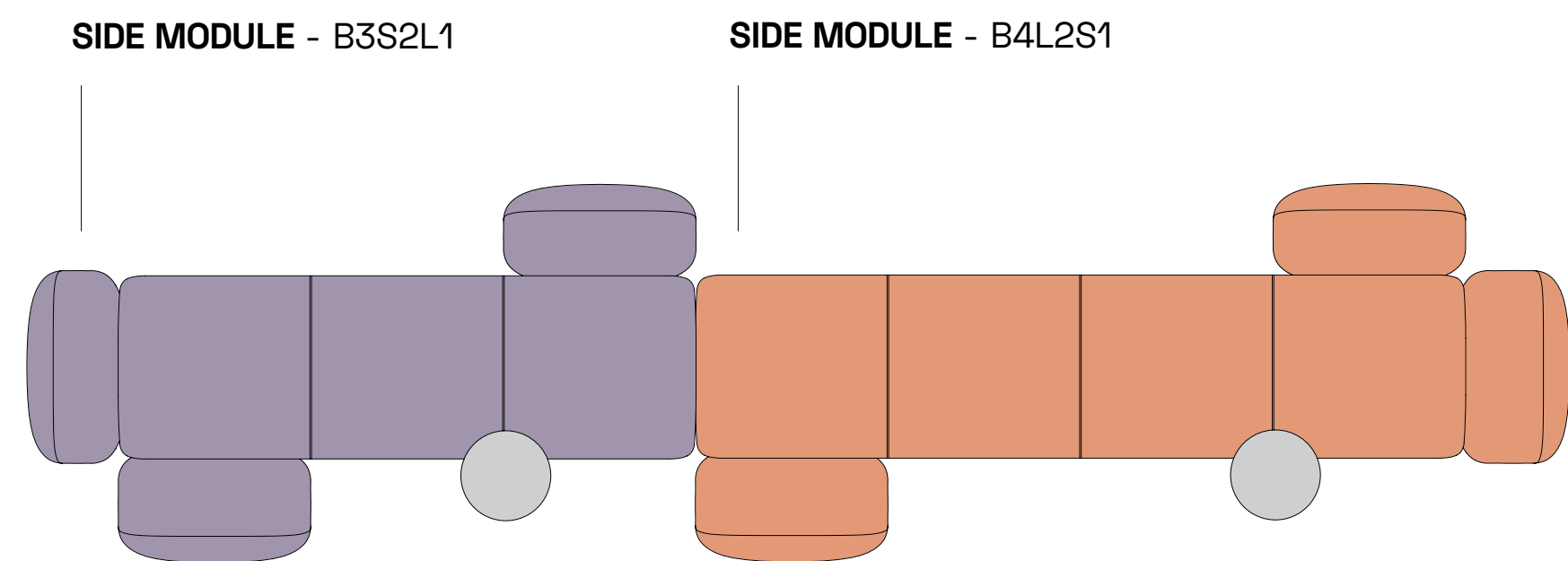

Dimensions (cm)

Side Modules - Group B

Side modules cannot be sold as a single unit. Modules can only be matched within the same group to create custom configurations.

Side Module
B4L2S1

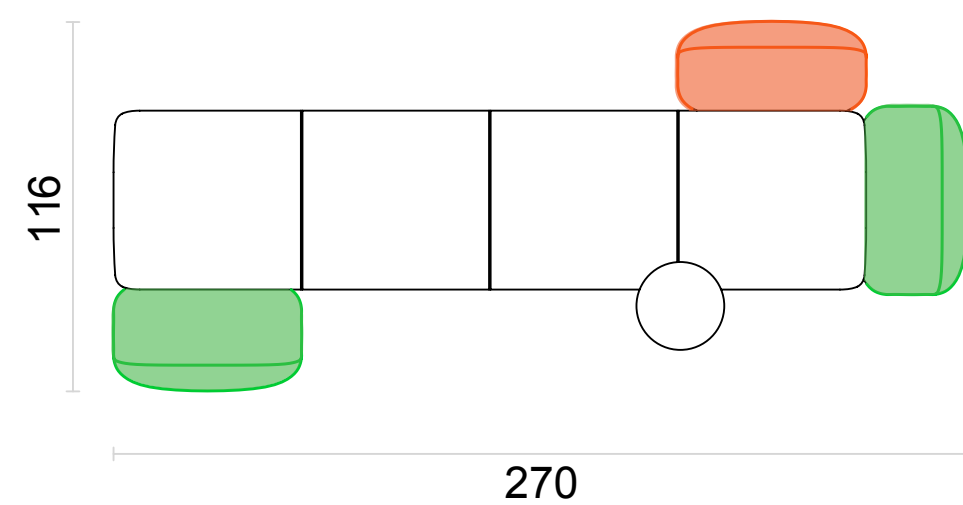

Side Module
B4S2L1

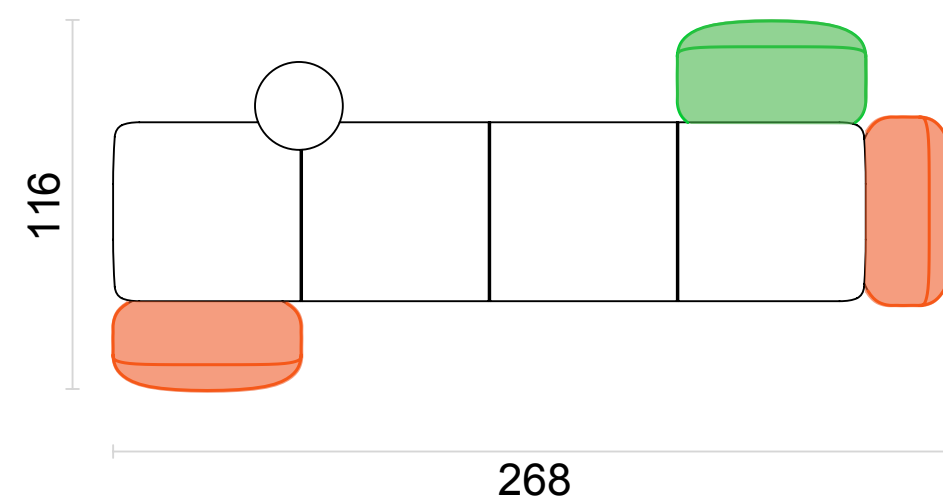

Side Module
B3S2L1

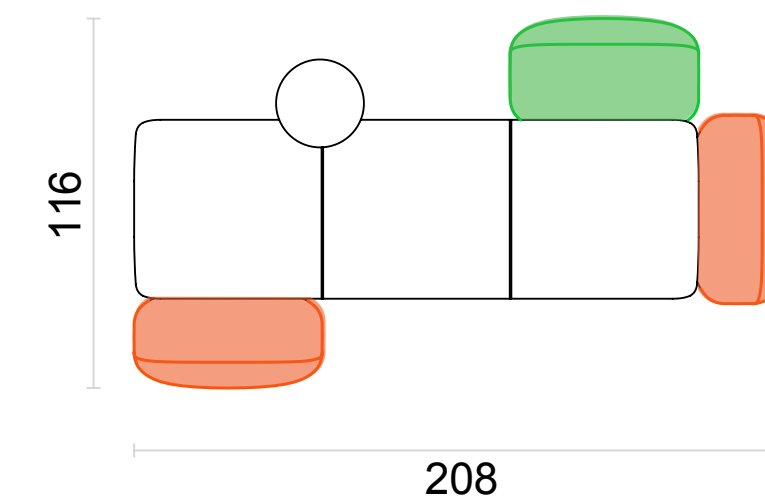

Dimensions (cm)

Side Modules - Group B

Side modules cannot be sold as a single unit. Modules can only be matched within the same group to create custom configurations.

Side Module
B3L2S1

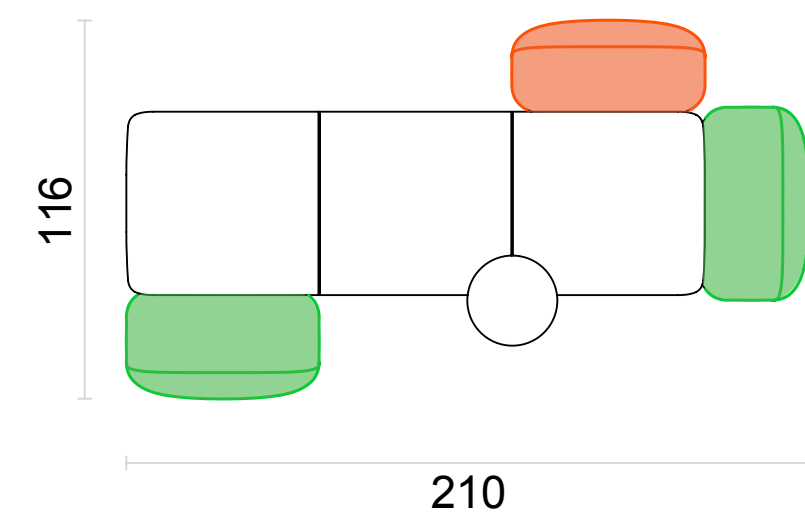

Side Module
B3S1L1

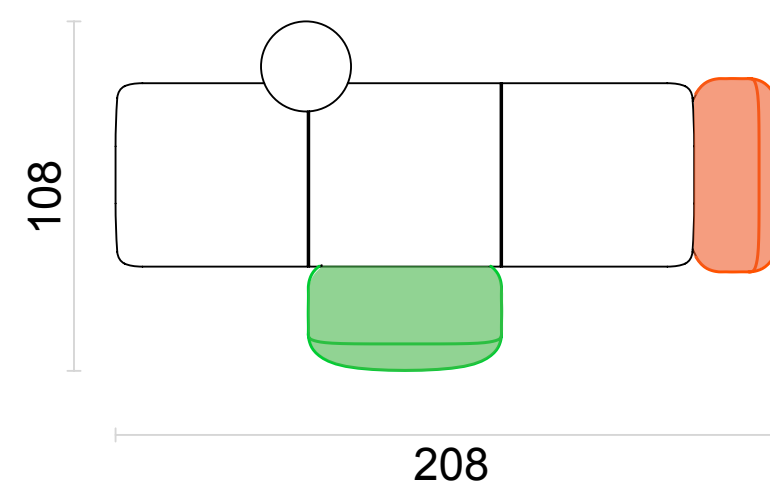

Side Module
B3L1S1

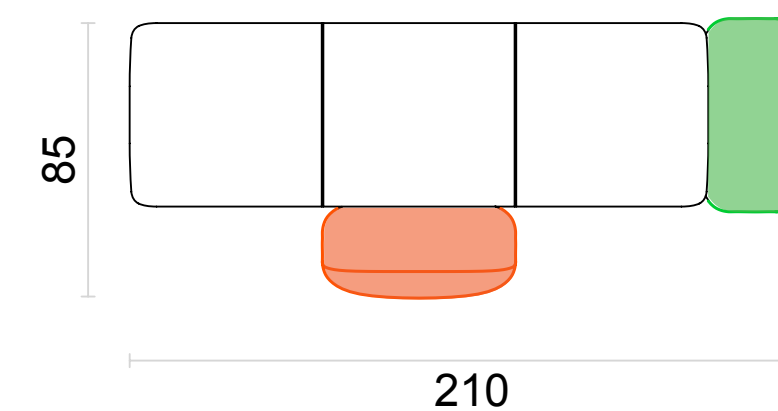

Dimensions (cm)

Side Modules - Group B

Side modules cannot be sold as a single unit. Modules can only be matched within the same group to create custom configurations.

Side Module
B3L2S1 F

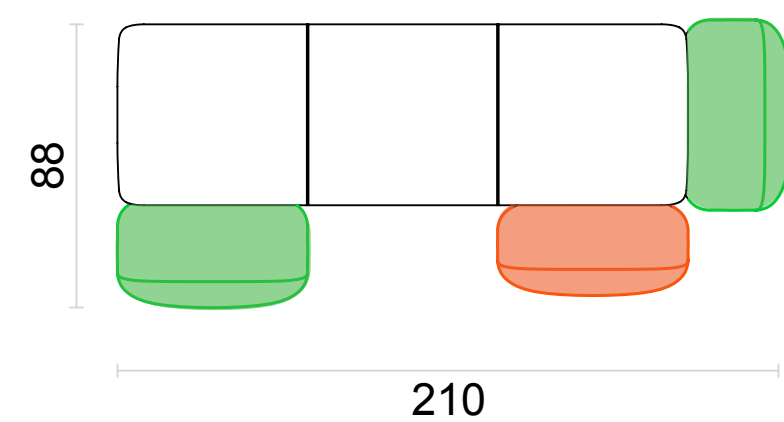

Side Module
B3S2L1 F

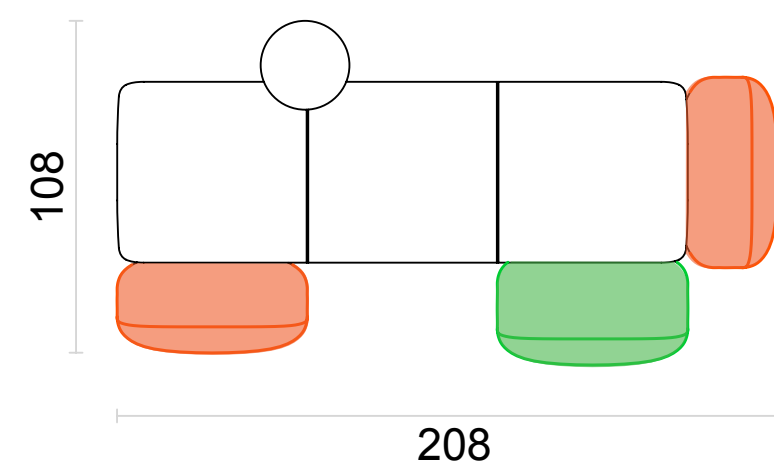

Side Module
B2L1S1

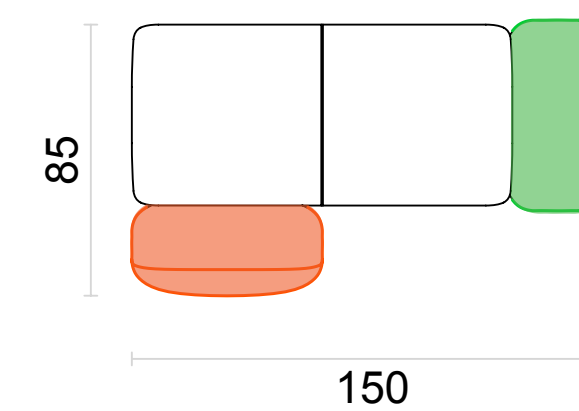

Dimensions (cm)

Side Modules - Group B

Side modules cannot be sold as a single unit. Modules can only be matched within the same group to create custom configurations.

Side Module
B2S2

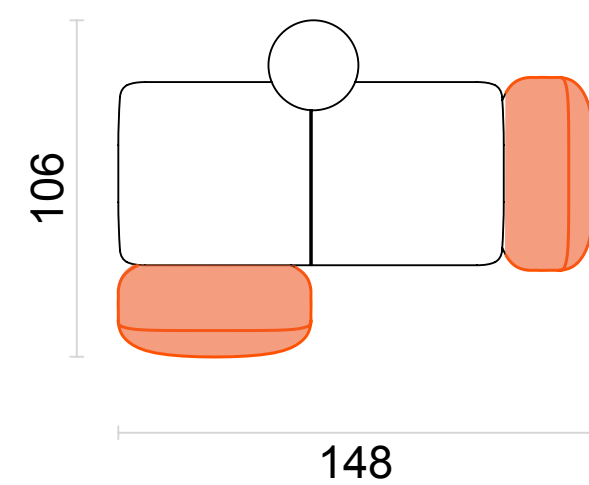

Side Module
B2S1L1

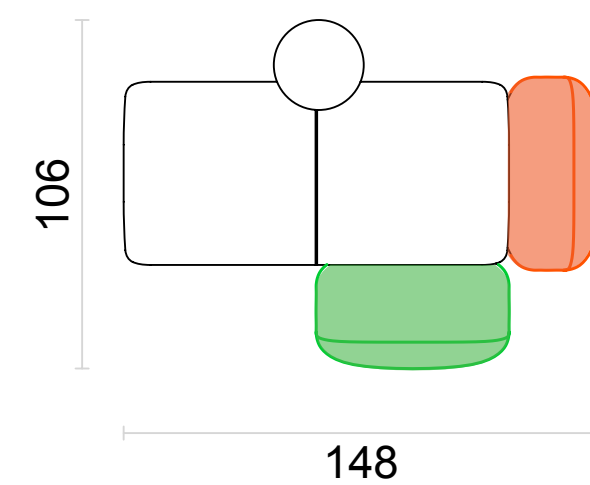

Side Module
B2L1S1 F

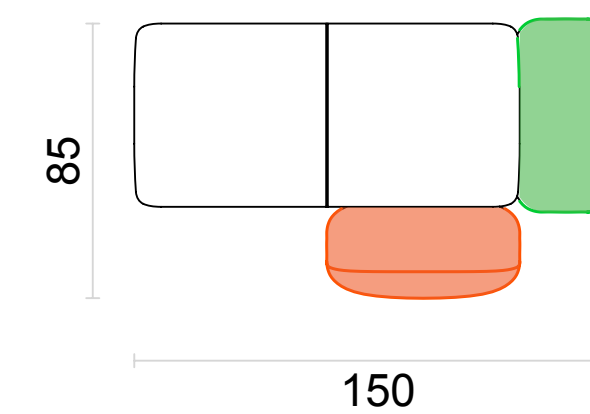

Dimensions (cm)

Middle Modules - Group B

Middle Module
B02L1S1

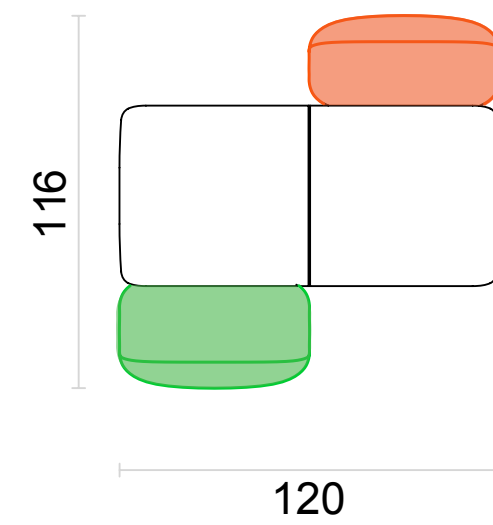

Middle Module
B03L1S1 F

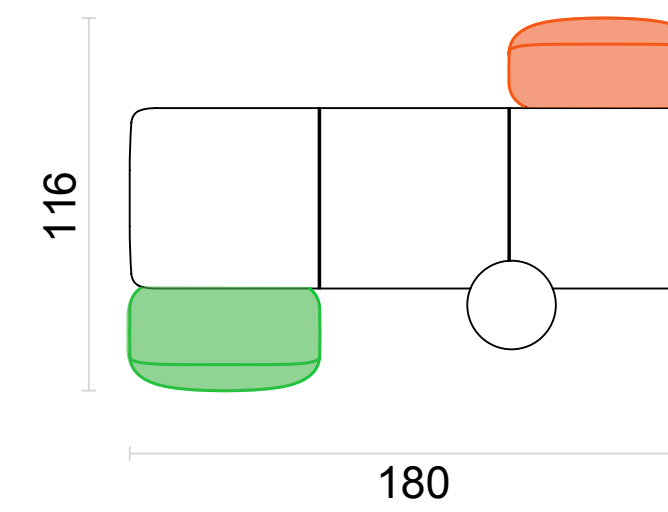



Metric

Seating Systems

Indoor

Downloads

2D & 3D FILES



PRODUCT IMAGES



CERTIFICATES



You can run this product with following system:



Metric

Seating Systems

Indoor



Technical Specifications		Standalone		
Product	Module Code	Package Dimensions (cm)	Volume (m³)	Weight (kg)
4 Seater 2 Short Backrest - 2 Tall Backrest	K4L2S2	250x65x30 quantity in box: 1 120x65x35 quantity in box: 2 90x65x35 quantity in box: 2	1,44	53.950
4 Seater 2 Short Backrest - 2 Tall Backrest	K4S2L2	250x65x30 quantity in box: 1 120x65x35 quantity in box: 2 90x65x35 quantity in box: 2	1,44	53.950
4 Seater 2 Short Backrest - 2 Tall Backrest	K4L2S2-F	250x65x30 quantity in box: 1 120x65x35 quantity in box: 2 90x65x35 quantity in box: 2	1,44	53.950
4 Seater 2 Short Backrest - 2 Tall Backrest	K4S2L2-F	250x65x30 quantity in box: 1 120x65x35 quantity in box: 2 90x65x35 quantity in box: 2	1,44	53.950

Technical Specifications		Standalone		
Product	Module Code	Package Dimensions (cm)	Volume (m³)	Weight (kg)
3 Seater 2 Short Backrest - 1 Tall Backrest	K3L1S2	190x65x30 quantity in box: 1 120x65x35 quantity in box: 2 90x65x35 quantity in box: 2	1,05	44.520
3 Seater 2 Short Backrest - 1 Tall Backrest	K3S2L1	190x65x30 quantity in box: 1 120x65x35 quantity in box: 1 90x65x35 quantity in box: 1	1,05	44.520
3 Seater 2 Short Backrest - 1 Tall Backrest	K3L1S2-F	190x65x30 quantity in box: 1 120x65x35 quantity in box: 1 90x65x35 quantity in box: 2	1,05	44.520
3 Seater 2 Short Backrest - 1 Tall Backrest	K3S2L1-F	190x65x30 quantity in box: 1 120x65x35 quantity in box: 1 90x65x35 quantity in box: 2	1,05	44.520

Technical Specifications		Tablet Arm							
Size	Package Dimensions (cm)	Neolith 18 mm		Lacquer 18 mm		Veneer 18 mm		Marble 18 mm	
		Volume (m³)	Weight (kg)	Volume (m³)	Weight (kg)	Volume (m³)	Weight (kg)	Volume (m³)	Weight (kg)
28x28x55h	35x35x10 quantity in box: 1	1,70	152	1,70	180	2,40	160	2,40	220

Technical Specifications			Group A	
Product	Module Code	Package Dimensions (cm)	Volume (m³)	Weight (kg)
1 Short Backrest 2 Tall Backrest	A4L2S1	250x65x30 quantity in box: 1 120x65x35 quantity in box: 2 90x65x35 quantity in box: 1	1,24	67.05
2 Short Backrest 1 Tall Backrest	A4S2L1	250x65x30 quantity in box: 1 120x65x35 quantity in box: 1 90x65x35 quantity in box: 2	1,17	65.05
2 Short Backrest 1 Tall Backrest	A3S2L1	190x65x30 quantity in box: 1 120x65x35 quantity in box: 1 90x65x35 quantity in box: 2	1,05	72.605
1 Short Backrest 2 Tall Backrest	A3L2S1	190x65x30 quantity in box: 1 120x65x35 quantity in box: 1 90x65x35 quantity in box: 2	1,05	57.605
1 Short Backrest 1 Tall Backrest	A3S1L1	190x65x30 quantity in box: 1 120x65x35 quantity in box: 1 90x65x35 quantity in box: 1	0,85	44.520
1 Short Backrest 2 Tall Backrest	A3L2S1-F	190x65x30 quantity in box: 1 120x65x35 quantity in box: 2 90x65x35 quantity in box: 1	1,12	57.605
2 Short Backrest 1 Tall Backrest	A3S2L1-F	190x65x30 quantity in box: 1 120x65x35 quantity in box: 1 90x65x35 quantity in box: 2	1,05	55.605

Technical Specifications			Group A	
Product	Module Code	Package Dimensions (cm)	Volume (m³)	Weight (kg)
1 Short Backrest 1 Tall Backrest	A3L1S1	190x65x30 quantity in box: 1 120x65x35 quantity in box: 1 90x65x35 quantity in box: 1	0,85	44.520
1 Short Backrest 1 Tall Backrest	A2L1S1	130x65x30 quantity in box: 1 120x65x35 quantity in box: 1 90x65x35 quantity in box: 1	0,73	34.320
1 Short Backrest 1 Tall Backrest	A2S1L1	130x65x30 quantity in box: 1 120x65x35 quantity in box: 1 90x65x35 quantity in box: 1	0,73	34.320
1 Short Backrest 1 Tall Backrest	A2L1S1-F	130x65x30 quantity in box: 1 120x65x35 quantity in box: 1 90x65x35 quantity in box: 1	0,73	34.320
1 Short Backrest	A2S2	130x65x30 quantity in box: 1 90x65x35 quantity in box: 2	0,66	32.320
1 Short Backrest 1 Tall Backrest	Middle A02S1L1	130x65x30 quantity in box: 1 120x65x35 quantity in box: 2 90x65x35 quantity in box: 1	1	-65
1 Short Backrest 1 Tall Backrest	Middle A03L1S1	190x65x30 quantity in box: 1 120x65x35 quantity in box: 1 90x65x35 quantity in box: 2	1,05	81

Technical Specifications		Group B		
Product	Module Code	Package Dimensions (cm)	Volume (m³)	Weight (kg)
1 Short Backrest 2 Tall Backrest	B4L2S1	250x65x30 quantity in box: 1 120x65x35 quantity in box: 2 90x65x35 quantity in box: 1	1,24	67.05
2 Short Backrest 1 Tall Backrest	B4S2L1	250x65x30 quantity in box: 1 120x65x35 quantity in box: 1 90x65x35 quantity in box: 2	1,17	65.05
2 Short Backrest 1 Tall Backrest	B3S2L1	190x65x30 quantity in box: 1 120x65x35 quantity in box: 1 90x65x35 quantity in box: 2	1,05	72.605
1 Short Backrest 2 Tall Backrest	B3L2S1	190x65x30 quantity in box: 1 120x65x35 quantity in box: 2 90x65x35 quantity in box: 1	1,12	57.605
1 Short Backrest 1 Tall Backrest	B3S1L1	190x65x30 quantity in box: 1 120x65x35 quantity in box: 1 90x65x35 quantity in box: 1	0,85	44.520
1 Short Backrest 2 Tall Backrest	B3L2S1-F	190x65x30 quantity in box: 1 120x65x35 quantity in box: 2 90x65x35 quantity in box: 1	1,12	57.605
2 Short Backrest 1 Tall Backrest	B3S2L1-F	250x65x30 quantity in box: 1 120x65x35 quantity in box: 1 90x65x35 quantity in box: 2	1,05	55.605

Technical Specifications		Group B		
Product	Module Code	Package Dimensions (cm)	Volume (m³)	Weight (kg)
1 Short Backrest 1 Tall Backrest	B3L1S1	250x65x30 quantity in box: 1 120x65x35 quantity in box: 1 90x65x35 quantity in box: 1	0,85	44.520
1 Short Backrest 1 Tall Backrest	B2L1S1	130x65x30 quantity in box: 1 120x65x35 quantity in box: 1 90x65x35 quantity in box: 1	0,73	34.320
1 Short Backrest 1 Tall Backrest	B2S1L1	130x65x30 quantity in box: 1 120x65x35 quantity in box: 1 90x65x35 quantity in box: 1	0,73	34.320
1 Short Backrest 1 Tall Backrest	B2L1S1-F	130x65x30 quantity in box: 1 120x65x35 quantity in box: 1 90x65x35 quantity in box: 1	0,73	34.320
1 Short Backrest	B2S2	130x65x30 quantity in box: 1 90x65x35 quantity in box: 2	0,66	32.320
1 Short Backrest 1 Tall Backrest	Middle B02S1L1	130x65x30 quantity in box: 1 120x65x35 quantity in box: 1 90x65x35 quantity in box: 2	0,94	65
1 Short Backrest 1 Tall Backrest	Middle B03L1S1-F	190x65x30 quantity in box: 1 120x65x35 quantity in box: 1 90x65x35 quantity in box: 1	0,85	81

[CARE AND MAINTENANCE](#)

Care and maintenance instructions & warranty certificate **click and download**



Metric

Seating Systems

Indoor



www.bt.design

Showroom

Istanbul
istanbul@bt.design

Ankara
ankara@bt.design

Londra
london@bt.design

Factory

Istanbul
fabrika@bt.design

Bulgaria
europa@bt.design

Export

export@bt.design